

Part 4

QUESTION 301

An ISDN link can be encapsulated using either PPP or HDLC. What are the advantages of using PPP? (Select two answer choices)

- A. PPP is easier to configure and maintain than HDLC.
- B. PPP is consistently implemented among different equipment vendors.
- C. PPP will run faster and more efficiently than HDLC on circuit-switched ISDN links.
- D. PPP authentication will prevent unauthorized callers from establishing an ISDN circuit.
- E. PPP can be routed across public facilities, while HDLC is not routable in circuit-switched networks.
- F. PPP supports asynchronous communication.

Answer: B, D

Explanation: PPP has numerous advantages over HDLC. Unlike HDLC which is Cisco proprietary, PPP was designed for multi-protocol interoperability. Secondly, PPP supports authentication, using either PAP or CHAP. Finally, PPP supports error correction and the use of bonded multilink circuits.

Incorrect Answers:

- A. The default encapsulation is HDLC. PPP must be explicitly configured and there are many more options available with it, so it is more complicated than HDLC.
- C. HDLC is slightly more efficient than PPP.
- E. Neither PPP nor HDLC work in public circuit-switched environments.
- F. Although this is true, it would not be considered an advantage on an ISDN link, as ISDN signaling is not asynchronous.

Reference: CCNA Self-Study CCNA ICND exam certification Guide (Cisco Press, ISBN 1-58720-083-X) Page 308-310

QUESTION 302

A new frame relay connection is being brought up. Which of the following are frame relay LMI type options that can be configured on this new link? (Select all that apply.)

- A. EIA/TIA
- B. Q.932
- C. Q.933A
- D. IEEE
- E. Cisco
- F. Annex D

Answer: C, E, F

Explanation:

There are three options for frame relay LMI types. The default is Cisco, which is proprietary to Cisco routers. The second option is ANSI, which is also known as Annex D. The final option is the ITU standard, which is known as Annex A or Q.933A.

Reference:

CCNA Self-Study CCNA ICND exam certification Guide (Cisco Press, ISBN 1-58720-083-X) Page 382

QUESTION 303

You are troubleshooting a frame relay connection and wish to view the LMI traffic stats. Which command should you issue?

- A. Show interface lmi
- B. Show frame-relay lmi
- C. Show interface frame-relay
- D. Debug frame-relay interface.

Answer: B

Explanation:

To view Frame-Relay LMI statistics, enter the command "show frame-relay lmi"
This will view various statistics on the link, including the LMI status enquiries that were sent and received on the interface.

QUESTION 304

You have a router that's connected to a Frame Relay WAN link using a serial DTE interface. What determines the interface clock rate?

- A. It is determined by the CSU/DSU.
- B. It is determined by the far end device.
- C. It is specified in the clock rate command.
- D. It is determined by the Layer 1 bit stream timing.

Answer: A

Explanation: In Frame-relay you do not talk about Routers and for in particular not a "far-end-router" (not B).

The correct answer, if we talk about Frame-relay which is what the question is talking about, is the CSU/DSU, which determines the clock rate.

QUESTION 305

The Certkiller network consists of 3 frame relay sites as shown in the diagram below:



Which encapsulation type is appropriate to use in this design if the routers are all from different vendors?

- A. ietf
- B. cisco
- C. ansi
- D. q953a
- E. ieee

Answer: A

Explanation:

Cisco routers use the Cisco frame relay encapsulation type for all frame relay interfaces. This is perfectly acceptable in all routers within the network are Cisco routers, but problems can arise for frame relay networks when a router from a different vendor is used. To prevent these problems, the industry standard IETF frame relay encapsulation should be used. To configure this, use the "encapsulation frame-relay ietf" interface command.

QUESTION 306

Which statements are true about EIGRP successor routes? (Choose two)

- A. A successor route is used by EIGRP to forward traffic to a destination.
- B. Successor routes are saved in the topology table to be used if the primary route fails.
- C. Successor routes are flagged as "active" in the routing table.
- D. A successor route may be backed up by a feasible successor route.
- E. Successor routes are stored in the neighbor table following the discovery process.
- F. Successors are not used in EIGRP.

Answer: B, D

Explanation:

The following are some terms relating to EIGRP:

1. Feasible Distance: The lowest calculated metric to each destination
2. Feasibility Condition: A condition that is met if a neighbor's advertised distance to a destination is lower than the router's Feasible Distance to that same destination.
3. Successor: The neighbor that has been selected as the next hop for a given destination

based on the Feasibility Condition.

Reference: Jeff Doyle, Routing TCP/IP, Volume I, Chapter 8: Enhanced Interior Gateway Routing Protocol (EIGRP), p.336-337, Cisco Press, (ISBN 1-57870-041-8)

Additional info:

The Feasible Condition is met when the receiving router has a Feasible Distance (FD) to a particular network and it receives an update from a neighbor with a lower advertised or Reported Distance (RD) to that network. The neighbor then becomes a Feasible Successor (FS) for that route because it is one hop closer to the destination network.

There may be a number of Feasible Successors in a meshed network environment.

The RD for a neighbor to reach a particular network must always be less than the FD for the local router to reach that same network. In this way EIGRP avoids routing loops. This is why routes that have RD larger than the FD are not entered into the Topology table.

Reference: Ravi Malhotra, IP Routing, Chapter 4: Enhanced Interior Gateway Routing Protocol (EIGRP), O'Reilly Press, January 2002 (ISBN 0-596-00275-0)

QUESTION 307

The Certkiller network is planning to utilize both the IGRP and EIGRP routing protocols in their network as shown below:



Router CK3 is using IGRP, while router CK1 is using EIGRP. Certkiller plans to add new routers and run EIGRP on them, but Certkiller does not want to configure redistribution.

Which AS numbering scheme should Certkiller implement?

- A. IGRP AS number 40; EIGRP AS number 41
- B. IGRP AS number 41; EIGRP AS number 40
- C. IGRP AS number 22; EIGRP AS number 22
- D. IGRP AS number 0; EIGRP AS number 0
- E. IGRP AS number 1; EIGRP AS number 255

Answer: C

Explanation:

EIGRP and IGRP will redistribute routes automatically, as long as the autonomous system numbers are the same for each protocol. With automatic redistribution, all networks shown in the network above will be reachable, with no additional configuration changes needed on the CK2 router.

Incorrect Answers:

- A, B, E. The AS numbers should be the same for both EIGRP and IGRP
 - D. EIGRP and IGRP both require an AS number greater than 0.
-

QUESTION 308

A network administrator needs to configure a router for a Frame Relay connection to a non-Cisco router.

Which of the following commands will prepare the WAN interface for this connection?

- A. Router(config-if)# encapsulation frame-relay q933a
- B. Router(config-if)# encapsulation frame-relay ansi
- C. Router(config-if)# encapsulation frame-relay ietf
- D. Router(config-if)# encapsulation frame-relay isl
- E. None of the above

Answer: C

Explanation:

The IETF Frame Relay encapsulation should be used when connecting a Cisco router to non-Cisco equipment across a Frame Relay network. The IETF Frame Relay encapsulation allows interoperability between equipment from multiple vendors.

Both Cisco and IETF encapsulations for Frame Relay can be configured on a per-virtual-circuit (VC) basis. This gives greater flexibility when configuring Frame Relay in a multi-vendor environment. A user can specify the Frame Relay encapsulation types to be used on different virtual circuits configured under the same physical interface.

Incorrect Answers:

- A, B. These are frame relay LMI types and are not used as encapsulation types.
 - D. ISL is a trunking encapsulation type and has nothing to do with frame relay.
-

QUESTION 309

In the context of configuring dial-on-demand routing using ISDN, what is the purpose of the dialer-list command?

- A. to identify valid numbers for incoming calls
- B. to define the type of ISDN switch at the central office
- C. to specify the list of outgoing phone numbers used by the router
- D. to associate a dial configuration with a physical interface
- E. to define interesting traffic that will enable the link

Answer: E

QUESTION 310

Exhibit, show interfaces serial 0/0 output exhibit

```
Certkiller3# show interfaces serial 0/0
Serial0/0 is up, line protocol is down
Hardware is HD64570
Internet address is 192.168.100.1/24
MTU 1500 bytes, BW 1544 Kbit, DLY 20000 usec,
  reliability 255/255, txload 1/255, rxload 1/255
Encapsulation HDLC, loopback not set
Keepalive set (10 sec)
```

Study the exhibit.

What are possible causes for the status of this interface? Select three.

- A. The interface is shut down.
- B. No keepalive messages are received.
- C. The clockrate is not set.
- D. No loopback address is set.
- E. No cable is attached to the interface.
- F. There is a mismatch in the encapsulation type.

Answer: B, C, F

QUESTION 311

You are logged into a router and wish to view the layer 3 information about your neighboring Cisco routers. What IOS command gives layer 3 information for of the directly connected router interfaces?

- A. show ip links
- B. show cdp neighbor
- C. show cdp neighbor detail
- D. show ip clients
- E. show ip route
- F. None of the above

Answer: C

Explanation:

To display detailed information about neighboring devices discovered using Cisco Discovery Protocol (CDP), use the show cdp neighbors privileged EXEC command. Detail - (Optional) Displays detailed information about a neighbor (or neighbors) including network address, enabled protocols, hold time, and software version.

Incorrect Answers:

- A, D. These are invalid commands.
- B. The "show cdp neighbor" command, without the "detail" keyword will not display the additional layer 3 protocol information.
- E. This will show all routes from all other routers within the domain. We wish to see information from just the direct interface neighbors.

QUESTION 312

While troubleshooting a connectivity problem on the network, you issue the ping

command from your PC command prompt, but the output shows "request times out."

At which OSI layer is this problem associated with?

- A. The data link layer
- B. The application layer
- C. The access layer
- D. The session layer
- E. The network layer

Answer: E

Explanation:

TCP/IP includes ICMP, a protocol designed to help manage and control the operation of a TCP/IP network. The ICMP protocol provides a wide variety of information about a network's health and operational status. Control message is the most descriptive part of a name. ICMP helps control and manage IP's work and therefore is considered part of TCP/IP's network layer.

Reference:

CCNA Self-Study CCNA ICND exam certification Guide (Cisco Press, ISBN 1-58720-083-X) page 277.

QUESTION 313

You download a file from an FTP site on the Internet. What is the highest layer in the OSI model used in this FTP operation?

- A. Application
- B. Presentation
- C. Session
- D. Transport
- E. Internet
- F. Data Link
- G. Physical

Answer: A

Explanation:

Layer 7 is the application layer, which is the highest layer in the OSI model. This layer describes the use of end user applications, such as opening movie files (avi, mpeg, etc) used Microsoft Office applications, using WWW browsers, using Telnet, and using FTP.

QUESTION 314

A host computer has been correctly configured with a static IP address, but the default gateway is incorrectly set. Which layer of the OSI model will be first affected by this configuration error?

- A. Layer 1
- B. Layer 2
- C. Layer 3
- D. Layer 4
- E. Layer 5
- F. Layer 6
- E. Layer 7

Answer: C

Explanation : IP Addressing and IP routing resides on the OSI Network layer, which is layer 3.

QUESTION 315

Which layer of the OSI reference model is responsible for ensuring reliable end-to-end delivery of data?

- A. Application
- B. Presentation
- C. Session
- D. Transport
- E. Network
- F. Data-Link

Answer: D

Explanation:

A key function of the transport layer is to provide connection services for the protocols and applications that run at the levels above it. These can be categorized as either connection-oriented services or connectionless services. Some protocol suites, such as TCP/IP, provide both a connection-oriented and a connectionless transport layer protocol, to suit the needs of different applications.

The transport layer is also the place in the layer stack where functions are normally included to add features to end-to-end data transport. Where network layer protocols are normally concerned with just "best effort" communications, where delivery is not guaranteed. Transport layer protocols are given intelligence in the form of algorithms that ensure that reliable and efficient communication between devices takes place. This encompasses several related jobs, including lost transmission detection and handling, and managing the rate at which data is sent to ensure that the receiving device is not overwhelmed.

Transmission quality, meaning ensuring that transmissions are received as sent, is so important that some networking references define the transport layer on the basis of reliability and flow-control functions. However, not all transport layer protocols provide these services. Just as a protocol suite may have a connection-oriented and a connectionless transport layer protocol, it may also have one that provides reliability and data management services, and one that does not. Again, this is the case with TCP/IP:

there is one main transport layer protocol; TCP, that includes reliability and flow control features, and a second, UDP, that doesn't.

QUESTION 316

Drag and Drop

As a Certkiller.com network technician you are required to drag the network problems to the correct OSI layers.

Physical Layer Problems

Place here
Place here
Place here

Data Link Layer Problems

Place here
Place here
Place here

Select from these

router serial line down	router serial line up; no CDP neighbors
router serial line protocol down	dialup authentication failure
switch port link light is on	router serial line encapsulation failure
excessive Ethernet collisions	

Answer:

As a Certkiller.com network technician you are required to drag the network problems to the correct OSI layers.

Physical Layer Problems

router serial line down
switch port link light is on
excessive Ethernet collisions

Data Link Layer Problems

router serial line protocol down
router serial line up; no CDP neighbors
dialup authentication failure
router serial line encapsulation failure

QUESTION 317

A Certkiller .com technician is troubleshooting connectivity problems between two routers that are directly connected through the serial line. The technician notices that the serial line is up but cannot see any neighbors displayed in the output of the show cdp neighbors command.

In which OSI layer is the problem most likely occurring?

- A. Physical
- B. Data link
- C. Network layer
- D. Transport layer
- E. Application layer

Answer: B

Explanation:

As the question states that serial line is up, it means the problem is not on the Network layer. The administrator cannot see any output by issuing the show cdp neighbors command. It means that CDP is disabled and CDP is a protocol that runs over Layer 2 (the data link layer) on all Cisco routers, bridges, access servers, and switches.

QUESTION 318

There are 2 switches in the Certkiller LAN, with no routers. Ports 1, 2 & 3 are assigned to VLAN 1 in switch 1 and 2 and ports 4, 5 & 6 are assigned to VLAN 2 in both switches. These two switches are connected together via a trunked link. Which of the conditions below would verify trunk and VLAN operation? (Select all valid answers)

- A. Host 1 on VLAN 1 can ping Host 2 on VLAN 1
- B. Host 1 on VLAN 1 can ping Host 4 on VLAN 2
- C. Host 1 on VLAN 1 can not ping Host 2 on VLAN 1
- D. Host 4 on VLAN 2 can not ping Host 1 on VLAN 1
- E. Host 4 on VLAN 2 can ping Host 2 on VLAN 2

Answer: A, D, E

Explanation:

If there is no router present, only hosts in the same VLAN will be able to ping each other. In order for any host on one VLAN to communicate with a host on another VLAN, the traffic must pass through a router. Host within the same VLAN will be able to ping each other, even though they reside on different switches, as long as the switches have a trunk connection configured between them.

QUESTION 319

Study the exhibit below, which displays 2 Certkiller switches in the LAN:

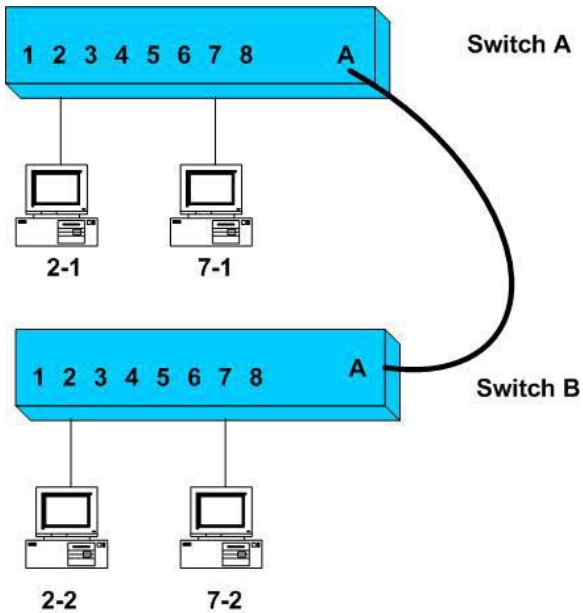

You are a network analyst on a network which contains two VLAN's as portrayed in the exhibit.

- Ports 1 through 4 on each switch are assigned to VLAN1
- Ports 5 through 8 on each switch are assigned to VLAN2.
- An ISL trunk link connects the two switches.

Based on this information, which of the following will be true? (Select all that apply)

- A. Host 2-1 can ping Host 2-2
- B. Host 2-1 can ping Host 7-2
- C. Host 2-1 can not ping Host 2-2
- D. Host 7-1 can not ping Host 2-2
- E. Host 7-1 can ping Host 7-2

Answer: A, D, E.

Explanation:

Without any routing taking place, hosts in one VLAN will only be able to reach other hosts in the same VLAN.

- A. Host 2-1 and Host 2-2 are both in VLAN1 and a ping should be successful.
- D. Host 7-1 is in VLAN3 while Host 2-2 is in VLAN1. A ping between those hosts should fail.
- E. Host 7-1 and Host 7-2 are both in VLAN1 and a ping should be successful.

Incorrect Answers:

- B. Host 2-1 and Host 7-2 are in different VLANs and a ping should fail.
- C. Host 2-1 and Host 2-2 are both in VLAN1 and a ping should be successful.

Reference: Steve McQuerry. Interconnecting Cisco Network Devices. (Cisco Press: 2000) pages 184 - 198 and 124.

QUESTION 320

You are a senior network administrator at Certkiller and your trusty junior administrator tells you that he failed his task of adding VLAN 50 to a Catalyst switch in the network.

You enter in the 'show vtp status' command and get this output:

```
CK2 # show vtp status
VTP Version                :2
Configuration Revision     :7
Maximum VLANs supported local :68
Number of existing VLANs   :8
VTP Operating Mode        :Client
VTP Domain Name           :corp
VTP Pruning Mode          :Disabled
VTP V2 Mode               :Disabled
VTP Traps Generation       :Disabled
MD5 digest                 :0x22 0xF3 0x1A
Configuration last modified by 172.18.22.15 at 5-28-03 1t:53:20
What commands must be issued on this switch to add VLAN 50 to the database?
(Choose two.)
```

- A. CK2 (config-if)# switchport access vlan 50
- B. CK2 (vlan)# vtp server
- C. CK2 (config)# config-revision 20
- D. CK2 (config)# vlan 50 name Tech
- E. CK2 (vlan)# vlan 50
- F. CK2 (vlan)# switchport trunk vlan 50

Answer: B, E

Explanation:

VTP operates in one of three modes:

- Server mode
- Client mode
- Transparent mode

For VTP to exchange information, some switches act as servers, and some act as clients.

VTP servers can create, modify, and delete VLANs and other configuration parameters for the entire VTP domain; this information, in turn, is propagated to the VTP clients and servers in that same domain. VTP servers save VLAN configurations in the Catalyst NVRAM, whereas in clients, the VLAN configuration is not stored at all. A VTP client cannot create, change or delete VLANs, nor can it save VLAN configurations in nonvolatile memory.

switchport mode { access | dynamic { auto | desirable } | trunk } Interface subcommand that configured the Interface for trunking.

QUESTION 321

Study the Exhibit below carefully:

```
London#show vtp
VTP Version:                2
Configuration Revision:     0
Maximum VLANs supported locally: 64
Number of existing VLANs:   5
VTP Operating Mode:         Client
VTP Domain Name:            London
VTP Pruning Mode:           Disabled
VTP V2 Mode:                Disabled
VTP Traps Generation:       Disabled
```

Based on the information given above, what is the VTP function of this particular switch?

- A. Learn and save VTP configuration in the running configuration.
- B. Create and change VLANs.
- C. Passes information about VTP configuration.
- D. VTP is disabled on this device.
- E. VTP is not saved to NVRAM.

Answer: C

Explanation:

From the output this switch is operating merely as VTP client, so it basically does as the VTP server says, and passes on information about VTP configuration to the next switch in line.

Incorrect Answers:

- A. This is incorrect because the function is redundant.
- B. This incorrect because the switch must be in server or transparent mode to create and change VLANs.
- D. This is incorrect because if VTP would be disabled, it wouldn't appear on the command output.
- E. If this were true, the VTP configuration information would not be displayed after being powered on.

QUESTION 322

Which of the following IOS commands could you use to troubleshoot a router connectivity problem on an IP network? (Select all valid answers)

- A. show ip route
- B. ipconfig
- C. tracert
- D. show interfaces
- E. traceroute
- F. ping
- G. All of the above

Answer: A, D, E, F

Explanation:

- A. The show ip route command displays the IP route table.
- D. The show interfaces EXEC command to display statistics for all interfaces configured on the router or access server.
- E. Traceroute is a valid router command, used to trace the path to a destination, and provide the latency associated with each hop.
- F. The ping command tests connectivity to a remote node.

Incorrect Answers:

- B, C. These are commands used on PC hosts. They are invalid router commands.

QUESTION 323

A new Catalyst switch is connected to an existing switch using a crossover cable. As a result of this, what would the switch port link lights display?

- A. The switch port link lights will be off on both switches indicating the ports are not connected.
- B. The switch port link light will be off on one switch indicating that STP has disabled the port.
- C. The switch port link lights will flash amber indicating an error.
- D. The switch port link lights will be green indicating normal operation.

Answer: D

Explanation:

To connect one Cisco switch to another Cisco switch, the crossover cable is the proper cable to use. So if you were to use one, the lights would be green indicating that all is well. If you were to connect a switch to a router, a server, or a PC host then a straight through cable should be used.

- Connect a Category 3, 4, or 5 crossover cable to any 10/100 port on the switch and to a 10BaseT port on the target hub or switch.
- Connect a Category 5 crossover cable to any 10/100 port on the switch and to a 100BaseTX port on the target hub or switch.

Reference:http://www.cisco.com/en/US/products/hw/switches/ps211/products_quick_start09186a00800ea827.html

QUESTION 324

What command verifies connectivity between two hosts by sending and receiving ICMP echo messages?

- A. ping
- B. tracet
- C. netstat

- D. show cdp neighbors detail
- E. show ip route
- F. traceroute

Answer: A

Explanation:

Packet Internet Groper (PING) uses ICMP echo requests and replies to verify network connectivity. It is most commonly used to verify connectivity to another device and to monitor the operational status of a device.

QUESTION 325

You are working as a network technician at Certkiller University, when you get a call from the Engineering Faculty. They're complaining that they're receiving obsolete information from the Business Faculty's network traffic broadcasts. What can you do to contain the Business Faculty's broadcast while still keeping it connected to the internet and the enterprise services of the University? (Select all valid answer choices)

- A. Use half and full-duplex Ethernet on the Engineering Department LAN
- B. Establish a VTP domain to minimize the obsolete traffic
- C. Change the switch IP address of the switch
- D. Create separate VLANs and subnets for the two departments and route between the two
- E. Provide greater bandwidth to the Engineering Department LAN
- F. Place the business department on a separate subnet and route between networks

Answer: D, F

Explanation:

In order to prevent the broadcast and link level multicast traffic separated between the departments, they need to be isolated at layer two. This can be accomplished in two ways. The first is to create separate VLANs and place each department into a different one. The second method would be to separate the two departments into two completely different networks, and route between them.

Incorrect Answers:

- A. Mixing the use of half and full duplex will make no difference to the number of broadcasts sent.
 - B. Trunking is only useful in networks that already contain VLANs.
 - C. This will make no difference, as all users will still be contained within the same IP subnet.
 - E. The amount of bandwidth involved will not have any impact on the amount of broadcasts that are sent and received.
-

QUESTION 326

Study the following exhibit:

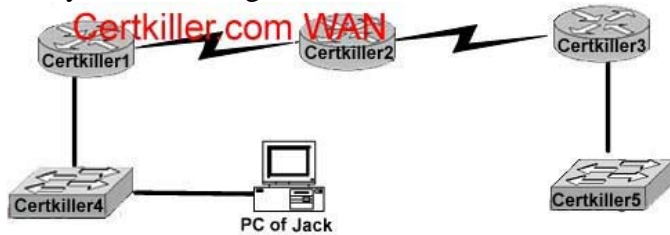

You are unable to log into the Certkiller 5 switch, as you have forgotten its IP address and you are too far away to log into it via the console port. You are unsure what the IP address of Certkiller 5 is and need to get this information.

How can you find the IP address of switch Certkiller 5?

- A. Issue the show ip route command on Router Certkiller 1.
- B. Issue the show cdp neighbors detail command on Router Certkiller 2.
- C. Issue the show arp command on Router Certkiller 3.
- D. Issue the show cdp neighbors detail command on Router Certkiller 3.
- E. Issue the show arp command on Router Certkiller 1.
- F. Issue the show ip route command on Router Certkiller 2.

Answer: D

Explanation:

To display detailed information about neighboring devices discovered using Cisco Discovery Protocol (CDP), use the show cdp neighbors privileged EXEC command. Detail - (Optional) Displays detailed information about a neighbor (or neighbors) including network address, enabled protocols, hold time, and software version.

QUESTION 327

Study the exhibit below:

London# show vtp status		Madrid# show vtp status	
VTP Version	: 2	VTP Version	: 2
Configuration Revision	: 0	Configuration Revision	: 0
Maximum VLANs supported locally	: 64	Maximum VLANs supported locally	: 64
Number of existing VLANs	: 5	Number of existing VLANs	: 5
VTP Operating Mode	: Server	VTP Operating Mode	: Server
VTP Domain Name	: London	VTP Domain Name	: Madrid
VTP Pruning Mode	: Disabled	VTP Pruning Mode	: Disable
VTP V2 Mode	: Disabled	VTP V2 Mode	: Disable
VTP Traps Generation	: Disabled	VTP Traps Generation	: Disable

The London switch and Madrid switch have both been configured for VTP, but they aren't sharing any VTP messages. Based on the above output, what do you suspect is the cause of this problem?

- A. VTP V2 mode is not in operation.
- B. VTP pruning mode is disabled.
- C. The VTP domain name is configured incorrectly.
- D. The VTP operating mode is not configured.
- E. The VTP version is configured incorrectly.

Answer: C

Explanation:

In order for VTP information to be shared between switches, they must be in the same VTP domain. Based on the output above, the switches appear to belong in completely separate domains, as their VTP domains are different, and they are both VTP servers.

QUESTION 328

The Certkiller switched LAN is displayed in the exhibit below:

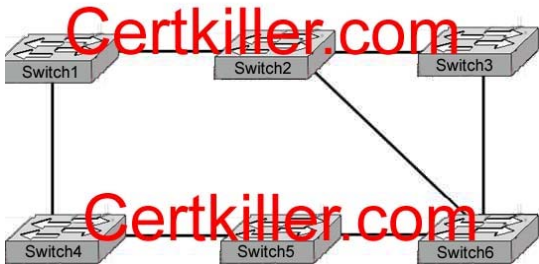

The switches are connected together as shown above, creating a loop. What is the type of loop that is caused in this setup, and what is the name of the protocol that prevents this from becoming a problem?

- A. routing loops, hold down timers
- B. switching loops, split horizon
- C. routing loops, split horizon
- D. switching loops, VTP
- E. routing loops, STP
- F. switching loops, STP

Answer: F

Explanation:

The Spanning-Tree Protocol (STP) prevents loops from being formed when switches or bridges are interconnected via multiple paths. Spanning-Tree Protocol implements the 802.1D IEEE algorithm by exchanging BPDUs with other switches to detect loops, and then removes the loop by shutting down selected bridge interfaces. This algorithm guarantees that there is one and only one active path between two network devices.

Incorrect Answers:

A, C, E. Switches operate at layer two, and only bridging or switching loops can be created.

B. Split Horizons are used to prevent routing loops in distance vector protocols.

D. VTP is the VLAN Trunking Protocol, which alone has no mechanism to prevent loops in the network from becoming an issue. The VTP process relies on the STP for loop detection and prevention.

QUESTION 329

After connecting a PC to an available port on a switch, you find that the PC can not access any of the resources on the LAN. No other PC's connected to the switch appear to be having any issues. What is the most likely cause for this problem?

- A. The router lacks a routing table entry for the new host
- B. The host switch port is assigned to the incorrect VLAN
- C. The host MAC address is incorrectly configured
- D. A STP instance for the new host has not been initialized
- E. The switch does not have the MAC address hard coded in the CAM table.

Answer: B

Explanation:

Virtual LANs break up broadcast domains in a layer-two switched internetwork. If a host is in a different VLAN than the network services it needs to use, the packets must go through a router. If routing does not take place, the PC will be unable to communicate with any other devices not in the same VLAN. Answer B is the best answer for this question.

Incorrect Answers:

- A. The PC is unable to communicate with other LAN users. No router needs to even be installed for this to work.
- C, E. The MAC address of the PC does not need to be entered manually into the switch. The switch will dynamically learn of the MAC address of the PC.
- D. The STP algorithm does not need to have any end host information added in order for it to work.

QUESTION 330

You are attempting to troubleshoot some problems within your local network. Which of the following are router IOS commands that can be used to troubleshoot LAN connectivity problems? (Choose all that apply)

- A. ping
- B. tracet
- C. ipconfig
- D. show ip route
- E. winipcfg
- F. show interfaces
- G. All of the above

Answer: A, D, F

Explanation:

All three of these are valid Cisco IOS commands that can be used to verify and troubleshoot connectivity issues on a LAN or WAN.

Incorrect Answers:

- B. "Tracert" is not a valid Cisco IOS command. This command can be used while at the command prompt window of a PC, but the corresponding Cisco command is "tracert".
- C, E. These are commands that can be useful in troubleshooting connectivity problems with an individual PC, but they are not valid commands within a Cisco router.

QUESTION 331

Which router IOS commands can be used to troubleshoot LAN connectivity problems? Select three

- A. Ping
- B. Tracert
- C. Ipconfig
- D. Show ip route
- E. Winipcfg
- F. Show interfaces

Answer: A, D, F

QUESTION 332

Exhibit

```
Certkiller1#show vtp stat
VTP Version          : 2
Configuration Revision : 1
Maximum VLANs supported locally : 250
Number of existing VLANs : 6
VTP Operating Mode    : Server
VTP Domain Name      : Certkiller
VTP Pruning Mode      : Disabled
VTP V2 Mode           : Disabled
VTP Traps Generation : Disabled
MDS digest            : 0x8F 0x92 0x87 0x80 0x88 0x8F 0xDA 0x86
Configuration last modified by 0.0.0.0 at 3-1-93 00:03:32
Local updater ID is 0.0.0.0 (no valid interface found)

Certkiller2#show vtp stat
VTP Version          : 0
Configuration Revision : 0
Maximum VLANs supported locally : 250
Number of existing VLANs : 5
VTP Operating Mode    : Server
VTP Domain Name      : Certkiller
VTP Pruning Mode      : Disabled
VTP V2 Mode           : Disabled
VTP Traps Generation : Disabled
MDS digest            : 0xF3 0x03 0x4C 0x72 0xC8 0x68 0x29 0x62
Configuration last modified by 0.0.0.0 at 0-0-00 00:00:00
Local updater ID is 0.0.0.0 (no valid interface found)
```

Certkiller.com

Study the exhibit. Two switches named Certkiller 1 and Certkiller 2, connect through ports configured as trunks. The trunk ports on both switches have been configured correctly and both interfaces are up. VTP, however, is not passing VLAN information between the two switches. Based on the output of the show vtp status command from both switches, what is the problem?

- A. The domain names do not mach.
- B. Only one switch can in VTOP server mode in a domain
- C. The configuration revision numbers must match on the two switches.
- D. The local updater IP address has not been configured.
- E. The VTP timer settings must match.

Answer: A

Note that the domain names do not match. They are TeftKing and Certkiller .

QUESTION 333

To configure the VLAN trunking protocol to communicate VLAN information between two switches, what two requirements must be met? Select two.

- A. Each end of the trunk line must be set to IEEE 802.1E encapsulation.
- B. The VTP management domain name of both switches must be set the same.
- C. All ports on both the switches must be set as access port.
- D. One of the two switches must be configured as a VTP server.
- E. A rollover cable is required to connect the two switches together.
- F. A router must be used to forward VTP traffic between VLANs.

Answer: B, D

QUESTION 334

Drag and Drop

As a network technician at Certkiller.com you are required to match the characteristics to the correct category of Ethernet collision on the right. Not all characteristics are used.

Characteristics, select from these

- damaged frame retransmitted
- considered abnormal network operation
- caused by excessive media latency
- occasionally occur in normal network operation
- cannot occur on a shared media segment
- occurs after the first 64 bytes of a frame are transmitted
- frequently occurs in full-duplex operation
- jam signal sent to intentionally corrupt frame

Late collision

- place here
- place here
- place here

Local collision

- place here
- place here
- place here

Answer:

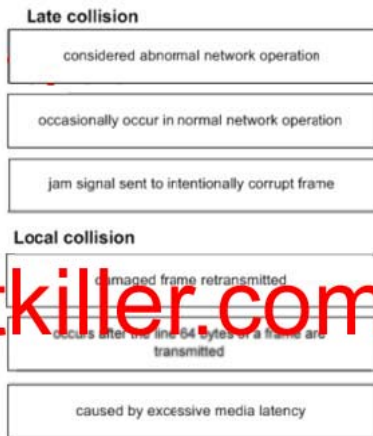

QUESTION 335

Which one of the following privileged EXEC mode IOS show commands will display the state of the OSPF DR/BDR (designated router / backup designated router) election process?

- A. CK1 # show ip ospf interface
- B. CK1 # show ip ospf priority
- C. CK1 # show ospf neighbor detail
- D. CK1 # show ospf processes
- E. CK1 # show ospf neighbor state

Answer: A

Explanation:

This command will display the router ID of both the DR and the BDR on the network segment that the particular interface is connected to.

Example:

```
Router1#show ip ospf interface ethernet 0
Ethernet0 is up, line protocol is up
Internet Address 10.10.1/24, Area 0
Process ID 1, Router ID 192.168.45.1, Network Type BROADCAST,
Cost: 10
Transmit Delay is 1 sec, State BDR, Priority 1
Designated Router (ID) 172.16.10.1, Interface address
10.10.10.2
Backup Designated router (ID) 192.168.45.1, Interface address
10.10.10.1
Timer intervals configured, Hello 10, Dead 40, Wait 40,
Retransmit 5
Hello due in 00:00:06
Index 1/1, flood queue length 0
Next 0x0(0)/0x0(0)
```

Last flood scan length is 2, maximum is 2
Last flood scan time is 0 msec, maximum is 4 msec
Neighbor Count is 1, Adjacent neighbor count is 1
Adjacent with neighbor 172.16.10.1 (Designated Router)
Suppress hello for 0 neighbor(s)

QUESTION 336

After logging into a router, you issue the "show ip route" command as shown below:

```
RouterCertkiller# Show ip route
```

```
<some output text omitted>
```

```
Gateway of last resort is not set.
```

```
1 172.16.0.0[110/84632] via 192.168.6.3,00:00:13, FastEthernet0/0  
R 192.168.3.0 [120/3] via 192.168.2.2,00:00:09, Serial0/0  
C 192.168.2.0 is directly connected, Serial0/0  
C 192.168.6.0 is directly connected, FastEthernet0/0
```

Based on the information above, what does the expression [120/3] represent in the second line of the routing table?

- A. 120 is the bandwidth allocation and 3 is the routing process number.
- B. 120 is the administrative distance and 3 is the metric for that route.
- C. The number 120 is the value of the update timer and 3 is the number of updates received.
- D. The number 120 is the UDP port for forwarding traffic and 3 is the number of bridges.

Answer: B

Explanation:

To decide which route to use, IOS uses a concept called Administrative Distance. Administrative distance is a number that denotes how believable an entire routing protocol is on a single router. The lower the number, the better, or more believable the routing protocol.

Route Type	Administrative Distance
• Connected	0
• EIGRP	90
• IGRP	100
• OSPF	110
• RIP	120

For RIP, the metric is the hop count, so in this case the route is 3 hops away.

Reference:

CCNA Self-Study CCNA ICND exam certification Guide (Cisco Press, ISBN 1-58720-083-X) Page 177

QUESTION 337

While trying to diagnose a routing problem in the network, you issue RIP debugging as displayed below:

```
RtrA#debug ip rip
```

Rip protocol debugging is on

RtrA#

1d05h: RIP: sending v1 update to 255.255.255.255 via FastEthernet0/0 (172.16.1.1)

1d05h: RIP: build update entries

1d05h: network 10.0.0.0 metric 1

1d05h: network 192.168.1.0 metric 2

1d05h: RIP: sending v1 update to 255.255.255.255 via Serial0/0 (10.0.8.1)

1d05h: RIP: build update entries

1d05h: network 172.16.0.0 metric 1

RtrA#

1d05h: RIP: received v1 update from 10.0.15.2 on Serial0/0

1d05h: 192.168.1.0 in 1 hops

1d05h: 192.168.0 in 16 hops (inaccessible)

Based on the output of the above exhibit, which two of the following statements are true? (Select two answer choices)

- A. A ping to 10.0.15.2 will be successful.
- B. RtrA has three interfaces that will take part in the RIP process.
- C. There are at least two routers participating in the RIP process.
- D. A ping to 192.168.168.2 will be successful.

Answer: A, C

Explanation:

By virtue of RIP receiving an update from 10.0.15.2 on Serial0/0, we know that there has to be another router in the picture, so C is a correct choice. Since the router received an update from the neighbor address, we know that there's a connection. Therefore, a ping can be successful, making answer choice A correct as well.

Incorrect Answers:

- B. This is incorrect because there isn't conclusive evidence to support this.
- D. This is incorrect because from the exhibit above the router is inaccessible, therefore the success of a ping would be unknown.

QUESTION 338

On your OSPF network, routers CK1 and CK2 belong to the same Ethernet network. However, they are unable to establish an adjacency over this link. While troubleshooting this problem, you issue the "show ip ospf interface Ethernet 0" command on each router. The output from these commands is displayed below:

CK1 : Ethernet is up, line protocol is up

Internet address 192.168.1.2/24, Area 0

Process ID 1, Router ID 192.168.31.33, Network Type BROADCAST, Cost: 10

Transmit Delay is 1 sec, State DR, Priority 1

Designated Router (ID) 192.168.31.33, Interface address 192.168.1.2

No backup designated router on this network

Time intervals configured, Hello 5, Dead 20, Wait 20, Retransmit 5

CK2 : Ethernet0 is up, line protocol is up

Internet address 192.168.1.1/24, Area 0
Process ID 2, Router ID 192.168.31.11, Network Type BROADCAST, Cost: 10
Transmit Delay is 1 sec, State DR, Priority 1
Designated Router (ID) 192.168.31.11, Interface address 192.168.1.1
No backup designated router on this network
Timer intervals configured, Hello 10, Dead 40, Wait 40, Retransmit 5
What is the underlying cause of the routers failing to become adjacent?

- A. The OSPF area is misconfigured.
- B. The priority on CK2 should be set lower.
- C. The cost on CK2 should be set lower.
- D. The hello and dead timers are misconfigured.
- E. You need to add a backup designated router to the network.
- F. The OSPF process ID numbers do not match.

Answer: D

Explanation:

OSPF routers must have the same hello intervals and the same dead intervals to exchange information. By default, the dead interval is four times the value of the hello interval. This means that a router has four chances to send a hello packet before being declared dead.

On broadcast OSPF networks, the default hello interval is 10 seconds and the default dead interval is 40 seconds. On nonbroadcast networks, the default hello interval is 30 seconds and the default dead interval is 120 seconds. These default values result in efficient OSPF operation and seldom need to be modified. As shown in the output, the hello timer on router CK1 was changed to 5 seconds, with the dead timer being set to 20 seconds.

Incorrect Answers:

- A. Both routers are configured to be in area 0.
- B. In this example the adjacency should come up regardless of which one was the DR/BRD. Therefore, setting the priority on one router will not solve this problem.
- C. This will not solve the adjacency issue.
- E. Only the DR is absolutely required on the Ethernet subnet, not the BDR.
- F. Unlike other protocols, the routing process ID's do not necessarily need to match in OSPF for routing to work.

QUESTION 339

A new router, named CK1, is being installed. You wish to add this router to your existing OSPF network. In doing so, you configure the following:

```
CK1 (config)# router ospf 1
```

```
CK1 (config-router)# network 10.10.10.0 255.255.255.0 area 0
```

After making this change, you notice that the networks attached to CK1 are not being learned by the other OSPF routers. What could be the cause of this?

- A. The AS is not correctly configured
- B. The network subnet mask is incorrectly configured
- C. The network wildcard mask is configured incorrectly
- D. The network number is not correctly configured
- E. The process id is configured incorrectly
- F. None of the above

Answer: C

Explanation:

The network command specifies the IP address (10.10.10.0) followed by the wildcard mask (not the subnet mask) and the area that is to be associated with the OSPF address range (in this case, area 0). The wildcard mask indicates in binary how much of the IP address must be matched with 0s indicating that the bits must match and 1 indicating that they may vary. Thus 0.0.0.255 or 00000000.00000000.00000000.11111111 indicates that any bit in the last octet can vary while all bits in the first 3 octets must match the network address (in other words, 10.10.10.xx)

QUESTION 340

Which one of the following EIGRP commands can check the IP addresses of the adjacent neighbors, as well as verifying the EIGRP retransmit intervals and queue counts?

- A. CK1 #show ip eigrp adjacency
- B. CK1 #show ip eigrp topology
- C. CK1 #show ip eigrp interfaces
- D. CK1 #show ip eigrp neighbors
- E. None of the above

Answer: D

Explanation:

The topology database contains information from all of the LSA packets that have been received for an area. The topology database is updated by the LSAs. Each router within the area has exactly the same topology database. All routers must have the same vision of the networks; otherwise, confusion, routing loops, and loss of connectivity will result. Note: The topology database is the router's view of the network within the area. It includes every OSPF router within the area and all the connected networks. This database is indeed a routing table, but a routing table for which no path decisions have been made; it is at present a topology database.

Reference: "CCNP BSCI Exam Certification Guide Third Edition" by Clare Gough, CCIE No. 2893, Page 197.

QUESTION 341

The Certkiller network consists of two routers as shown below:

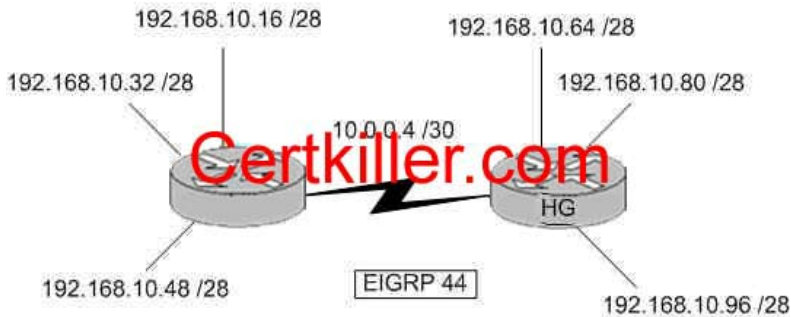

Both routers Certkiller and HG are configured for EIGRP. Unfortunately, users on the Certkiller networks are unable to reach users on the HG networks. Which command could you enter on Certkiller to correct this problem?

- A. Certkiller (config-router)# version 2
- B. Certkiller (config-router)# no auto-summary
- C. Certkiller (config-router)# redistribute eigrp 44
- D. Certkiller (config-router)# EIGRP log-neighbor-changes
- E. Certkiller (config-router)# default-information originate

Answer: B

Explanation:

By default, EIGRP will auto-summarize IP information at the network boundaries. In this example, the 192.168.10.0 network is subnetted into 6 separate networks. Therefore, each router will only advertise the 192.168.10.0/24 network to each other by default. To disable this function and transmit sub-prefix routing information across classful network boundaries, auto summarization must be disabled.

Incorrect Answers:

- A. There is only one version of EIGRP.
- C. Based on the diagram, each router is already configured for EIGRP 44.
- D. This will have no impact on the routes.
- E. This will generate a default route, which will be advertised to the other router. However, a default route is not needed, as the individual subnets need to be advertised, not a default route.

QUESTION 342

While troubleshooting a routing problem in your network, you utilize RIP debugging as shown below:

```

RtrA#debug ip rip
RIP protocol debugging is on
RtrA#
1405h: RIP: sending v1 update to 255.255.255.255 via FastEthernet0/0 (172.16.1.1)
1405h: RIP: build update entries
1405h: network 10.0.0.0 metric 1
1405h: network 192.168.1.0 metric 2
1405h: RIP: sending v1 update to 255.255.255.255 via Serial0/0 (10.0.8.1)
1405h: RIP: build update entries
1405h: network 172.16.0.0 metric 1
RtrA#
1405h: RIP: received v1 update from 10.0.15.2 on Serial0/0
1405h: 192.168.1.0 in 1 hops
1405h: 192.168.168.0 in 16 hops (inaccessible)

```

Based on the information provided, which of the following are true? (Select two answer choices)

A. This router was configured with the commands:

```
RtrA(config)#router rip  
RtrA(config-router)# network 172.16.0.0  
RtrA(config-router)# network 10.0.0.0
```

B. This router was configured with the commands:

```
RtrA(config)# router rip  
RtrA(config-router)# network 192.168.1.0  
RtrA(config-router)# network 10.0.0.0  
RtrA(config-router)# network 192.168.168.0
```

C. This router was configured with the commands:

```
RtrA(config)# router rip  
RtrA(config-router)# version 2  
RtrA(config-router)# network 172.16.0.0  
RtrA(config-router)# network 10.0.0.0
```

D. Split horizon was disabled on this router.

E. Network 192.168.168.0 will be displayed in the routing table.

F. Network 192.168.1.0 will be displayed in the routing table.

Answer: A, F

Explanation:

Based on the information provided, this RIP network is routing the 192.168.1.0, 172.16.0.0, and 10.0.0.0 networks. However, the 10.0.0.0 and 172.16.0.0 networks show that they are being advertised to the other router with a metric of 1, meaning that it is directly connected. Therefore, choice A is correct. Also, the 192.168.1.0 network was received on the serial 0/0 interface with a valid metric of 1 so this route will indeed be installed into the routing table.

Incorrect Answers:

B. The 192.168.0.0 networks are being received from other routers, so this particular one will not have this locally configured.

C. The output shows that RIP version 1 is being used, not RIP version 2.

D. There is no information to support this.

E. This network shows a metric of 16, which is the maximum number of hops for RIP so it is deemed inaccessible.

QUESTION 343

The Certkiller network consists of two routers, Peanut and Popcorn, as shown in the display below:

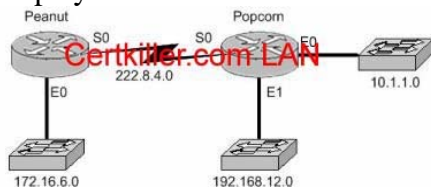

While troubleshooting a routing problem, you issue the "show ip protocols" command:

```
Popcorn# show ip protocols
```

```
Routing Protocol is "rip"  
Sending updates every 30 seconds, next due in 13 seconds  
Invalid after 180 seconds, hold down 180, flushed after 240  
Outgoing update filter list for all interfaces is  
Incoming update filter list for all interfaces is  
Redistribution: rip  
Default version control: send version 1, receive any version  
Interface Send Recv Triggered RIP Key-chain  
Ethernet0 1 12  
Ethernet1 1 12  
Serial 1 12  
Routing for Networks:  
222.8.4.0  
10.1.1.0  
Routing Information Sources:  
Gateway Distance Last Update  
222.8.4.1 120 00:00:04
```

The Peanut router is able to successfully ping the Serial 0 and Ethernet 0 interface of the Popcorn router, but a ping issued to the Ethernet 1 interface fails. Based on the above output, what are the potential causes of this problem? (Select two answer choices)

- A. The Popcorn router is not forwarding RIP updates.
- B. The Popcorn router did not include network 192.168.12.0 in its routing configuration.
- C. The Ethernet1 interface of the Popcorn router is shutdown.
- D. The clockrate is not present in the configuration of one of the routers.
- E. The Serial interface of the Popcorn router is not operating.

Answer: B, C

Explanation:

If the Popcorn router did not include the 192.168.12.0 network in the RIP configuration, then this network would not be advertised to the Peanut router, which would make it unreachable. Similarly, if the interface were administratively shut down, the Peanut router would not have a route to this network.

Incorrect Answers:

A, C, E. If any of these were true, then all of the Ethernet networks connected to the Popcorn router would be unreachable to the Peanut router, and not just Ethernet 1.

QUESTION 344

While troubleshooting network connectivity problems, the following two show commands were issued as shown below:

```
Test_King#show ip protocol  
Routing Protocol is "rip"  
Sending updates every 30 seconds, next due in 4 seconds
```

Invalid after 180 seconds, hold down 180, flushed after 240

Outgoing update filter list for all interfaces is not set

Incoming update filter list for all interfaces is not set

Redistribution rip

Default version control: send version 1, receive any version

Interface Send Recv Triggered RIP Key-chain

Serial0/0 1 1 2

Serial0/1 1 1 2

Automatic network summarization is in effect

Maximum path: 4

Routing for Networks:

10.0.0.0

Routing Information Sources:

Gateway Distance Last Update

10.168.11.14 120 00:00:22

Distance: (default is 120)

Certkiller #show ip interfaces brief

Interface	IP-Address	OK?	Method	Status
-----------	------------	-----	--------	--------

FastEthernet0/0	192.168.18.1	YES	manual	up
-----------------	--------------	-----	--------	----

Serial0/0	10.168.11.15	YES	manual	up
-----------	--------------	-----	--------	----

FastEthernet0/1	unassigned	YES	NVRAM	
-----------------	------------	-----	-------	--

administratively down

Serial0/1	192.168.11.21	YES	manual	up
-----------	---------------	-----	--------	----

Based on the output of the above exhibit, which two of the following statements are correct? (Select two answer choices)

- A. Router Certkiller will get routing updates on the Serial0/1 interface.
- B. Router Certkiller will issue routing updates out the Serial0/0 interface.
- C. Router Certkiller makes use of a link-state routing protocol.
- D. Router Certkiller will get routing updates on the Serial0/0 interface.
- E. Router Certkiller will issue routing updates out the FastEthernet0/0 interface.

Answer: B, D

Explanation:

Based on the information given, routing updates are being sent and received only from the directly connected neighbor with IP address 10.168.11.14. The locally connected interface in this case is Serial 0/0, as shown by the fact that this interface is using IP address 10.168.11.15, so it is on the same network.

Incorrect Answers:

A, E. Only interface Serial 0/0 appears to be passing routing information.

C. The only protocol that is being used here is RIP, which is a distance vector protocol.

QUESTION 345

Regarding the extended ping command; which of the statements below are true?

(Select all valid answer choices)

- A. The extended ping command is supported from user EXEC mode.
- B. The extended ping command is available from privileged EXEC mode.
- C. With the extended ping command you can specify the TCP and UDP port to be pinged.
- D. With the extended ping command you can specify the timeout value.
- E. With the extended ping command you can specify the datagram size.

Answer: B, D, E

Explanation:

The extended ping command works only at the privileged EXEC command line. Some of the extended ping command values include the datagram size and timeout value as shown:

Datagram size [100]: Size of the ping packet (in bytes). Default: 100 bytes.

Timeout in seconds [2]: Timeout interval. Default: 2 (seconds). The ping is declared successful only if the ECHO REPLY packet is received before this time interval.

Incorrect Answers:

- A. Regular pings are available in both user and privileged mode, but not extended pings.
- C. Ports can not be specified.

QUESTION 346

After executing the "show host" command, which of the information below would you see? (Select two answer choices.)

- A. The IP addresses of workstations allowed gain access to the router via an access list
- B. Permanent name-to-address mappings created using the ip host command.
- C. Temporary and permanent DNS entries.
- D. The names of the routers created using the hostname command.
- E. The length of time of users logged into the router, as well as the duration

Answer: B, D

Explanation:

The "show host" command lists all host names and corresponding IP addresses, as configured in the router.

Incorrect Answers:

- A, C. These are invalid.
- E. This is the result of the "show users" command, not the "show ip hosts" command.

QUESTION 347

When you use the ping command to send ICMP messages across a network, what's the most common request/reply pair you'll see? (Select one answer choice)

- A. Echo request and Echo reply
- B. ICMP hold and ICMP send
- C. ICMP request and ICMP reply
- D. Echo off and Echo on
- E. None of the above

Answer: A

Explanation:

The ICMP protocol uses Echo request and Echo reply with the Ping command. The PING utility is the most commonly used message to verify connectivity to a remote device within the network.

QUESTION 348

Three networks lie behind serial 0/0 interface of the Certkiller router: 172.16.10.0, 172.16.20.0, and 172.16.30.0. Unfortunately, users are unable to reach the 172.16.20.0 network. To troubleshoot the problem, you issue the "debug ip rip" and "show ip route" commands as shown below:

<some output text is omitted>

Certkiller 1# debug ip rip

ld00h: RIP:received v1 update from 172.16.100.2 on Serial0/0

ld00h: 172.16.10.0 in 1 hops

ld00h: 172.16.20.0 in 1 hops

ld00h: 172.16.30.0 in 1 hops

Certkiller 1# show ip route

Gateway of last resort is not set

172.16.0.0/24 is subnetted, 8 subnets

C 172.16.150.0 is directly connected, FastEthernet0/0

C 172.16.220.0 is directly connected, Loopback2

C 172.16.210.0 is directly connected, Loopback1

C 172.16.200.0 is directly connected, Loopback0

R 172.16.30.0 [120/1] via 172.16.100.2, 00:00:07, Serial0/0

S 172.16.20.0 [1/0] via 172.16.150.15

R 172.16.10.0 [120/1] via 172.16.100.2, 00:00:07, Serial0/0

C 172.16.100.0 is directly connected, Serial0/0

What could be the underlying cause of the problem?

- A. The 172.16.20.0 network is not located in Certkiller 1's routing table.
- B. There is no gateway of last resort on Certkiller 1.
- C. The static route for 172.16.20.0 is incorrect.
- D. The Certkiller 1 router is not receiving 172.16.20.0 updates.
- E. None of the above

Answer: C

Explanation:

The static route of 172.16.20.0 is incorrect. The "show ip route" shows that the network is connected via 172.16.150.15 instead of 172.16.100.2.

Incorrect Answers:

- A. The network is displayed in the table. The problem is that the route shows up as an incorrect static route, instead of a RIP route.
- B. Although the default route is not set, this does not explain why the 172.16.20.0 route is inaccessible.
- D. The RIP debugging shows that the route is indeed being learned via RIP. The problem is that a static route was configured, and the static route has a lower administrative distance than the RIP route. Therefore, the incorrect static route is installed into the routing table, rather than the correct RIP route.

QUESTION 349

You are a network administrator at Certkiller, Inc. and you're getting complaints that users on the Certkiller 2 Ethernet network can't access the Certkiller 1 site. To troubleshoot this, you begin by looking at the Certkiller 1 and Certkiller 2 router configurations as shown below:

```
Certkiller1# show running-config
```

```
<some output text omitted>
```

```
interface serial10/0
 ip address 10.0.1.1 255.255.255.0
 encapsulation frame-relay
!
router igrp 1
 network 10.0.0.0
```

```
Certkiller2# show running-config
```

```
<some output text omitted>
```

```
interface fastethernet0/0
 ip address 10.10.2.1 255.255.255.0

interface serial10/0
 ip address 10.10.1.2 255.255.255.0
 encapsulation frame-relay
!
router igrp 2
 network 10.0.0.0
```

Based on the above output, what is the underlying cause of this problem?

- A. Link state routing protocol is missing.
- B. Incorrectly configured IP addresses
- C. IGRP is incorrectly configured.
- D. Frame relay is not configured.
- E. None of the above

Answer: C

Explanation:

```
router igrp
```

To configure the Interior Gateway Routing Protocol (IGRP) routing process, use the router igrp global configuration command. To shut down an IGRP routing process, use the no form of this command.

router igrp autonomous-system

autonomous-system- Autonomous system number that identifies the routes to the other IGRP routers. It is also used to tag the routing information. The autonomous system must match for all IGRP routers in the network. The problem in this case is that Certkiller 1 is using IGRP 1, while Certkiller 2 is using IGRP 2.

QUESTION 350

You are a network technician at Certkiller , Inc. You are currently troubleshooting a routing issue on the Certkiller 1 router. You issue the show ip route command. The output from the command is displayed in the following exhibit:

Certkiller 1#show ip route

Codes: C - connected, S - static, I - IGRP, R- RIP, M - mobile, B - BGP

D - EIGRP, EX - EIGRP external, O - OSPF, IA - OSPF inner

area

E1 - OSPF external type 1, E2 - OSPF external type 2, E - EGP

i - IS-IS, L1 - IS-IS level-1, L2 - IS-IS level-2, * -

Candidate default

U - per-user static route

Gateway of last resort is not set

R 192.168.8.0/24 [120/1] via 192.168.2.2, 00:00:10, Serial0

C 192.168.9.0/24 is directly connected, Serial1

R 192.168.10.0/24 [120/7] via 192.168.9.1, 00:00:02, Serial1

R 192.168.11.0/24 [120/7] via 192.168.9.1, 00:00:03, Serial1

C 192.168.1.0/24 is directly connected, Ethernet0

C 192.168.2.0/24 is directly connected, Serial0

R 192.168.3.0/24 [120/1] via 192.168.2.2, 00:00:10, Serial0

R 192.168.4.0/24 [120/15] via 192.168.2.2, 00:00:10, Serial0

R 192.168.5.0/24 [120/15] via 192.168.2.2, 00:00:10, Serial0

R 192.168.6.0/24 [120/15] via 192.168.2.2, 00:00:10, Serial0

R 192.168.7.0/24 [120/1] via 192.168.2.2, 00:00:10, Serial0

Which one of the following routes WILL NOT be entered into its neighboring routers routing table?

A. R 192.168.11.0/24 [120/7] via 192.168.9.1, 00:00:03, Serial1

B. C 192.168.1.0/24 is directly connected, Ethernet0

C. R 192.168.8.0/24 [120/1] via 192.168.2.2, 00:00:10, Serial0

D. R 192.168.5.0/24 [120/15] via 192.168.2.2, 00:00:10, Serial0

E. None of the above

Answer: D

Explanation:

RIP has the maximum hop count of 15. This route already has a hop count of 15 and adding one would make it unreachable (see below). This route will be discarded.

R 202.30.5.0/24 [120/15] via 202.30.2.2, 00:00:10, Serial0

QUESTION 351

The Certkiller network consists of two routers connected via a point to point serial connection as shown below:



Users on Certkiller 1 are unable to connect to the Certkiller 2 network. Based on the configurations shown above, what could be the cause of this?

- A. The Maximum Transmission Unit size is too large.
- B. No loopback is set.
- C. The subnet mask is incorrect
- D. The encapsulation does not match at each end.
- E. There is an incorrect IP address.
- F. There is an incompatible bandwidth statement between routers.

Answer: E

Explanation:

The IP addresses are both on different subnets but are connected on Serial link. For the connection to work, the two interfaces must belong to the same IP subnet.

Incorrect Answers:

- A. The MTU is set at 1500 on each end, which is acceptable.
- B. Loopbacks are not required for this serial connection to function.
- C. The masks match, but the IP addresses do not.
- D. Based on the diagram above, both serial interfaces are set to HDLC encapsulation, which is the default encapsulation for serial interfaces.
- F. Although this is true, the bandwidth statements do not need to be set the same in order for this connection to work. The bandwidth statement is used by certain routing protocols, such as OSPF and EIGRP, but they have no impact on the actual function of the serial line.

QUESTION 352

The following routes exist in the Certkiller router:

- A. R 12.18.8.0/24 [120/1] via 12.18.2., 00:00:10, Serial0
- B. R 12.18.11.0/24 [120/7] via 12.18.9.1, 00:00:03, Serial1
- C. C 12.18.1.0/24 is directly connected, Ethernet0
- D. R 12.18.5.0/24 [120/15] via 12.18.2.2, 00:00:10, Serial0

Based on the above information, which route will not be entered into the routing

table of a neighboring router?

Answer: D

Explanation:

The number values inside of the brackets indicate the administrative distance and metric of the route. In this case the [120/15] means that the route has an AD of 120, which is the default for RIP, and a metric of 15. Since hop counts are used as the metric for RIP, it means that this route was learned by RIP and it is 15 hops away. When this route is advertised to a neighbor an additional hop is added, meaning that it will be advertised with a metric of 16. Since a RIP route with a metric of 16 is considered unreachable, it will not be added to the routing table of the neighbor router.

QUESTION 353

The routing table of the Corp router is displayed below:

```
Corp#show ip route
***
Gateway of last resort is not set:
C 192.168.13.0/24 is directly connected, Serial0/0/1
C 192.168.14.0/24 is directly connected, FastEthernet0/0
C 192.168.15.0/24 is directly connected, Serial0/0.102
C 192.168.20.0/24 is directly connected, Serial0/0.117
R 192.168.16.0/24 [120/1] via 192.168.15.2, 00:00:05, Serial0/0.102
R 192.168.17.0/24 [120/1] via 192.168.15.2, 00:00:05, Serial0/0.102
R 192.168.30.0/24 [120/2] via 192.168.20.2, 00:00:25, Serial0/0.117
R 192.168.19.0/24 [120/1] via 192.168.20.2, 00:00:25, Serial0/0.117
R 192.168.21.0/24 [120/3] via 192.168.20.2, 00:00:25, Serial0/0.117
R 192.168.214.0/24 [120/1] via 192.168.14.2, 00:00:22, FastEthernet0/0
```

The Corp router receives an IP packet with a source IP address of 192.168.214.20 and a destination address of 192.168.22.3. Based on the information above, what will the router do with this packet?

- A. It will encapsulate the packet as Frame Relay and forward it out interface Serial 0/0.117.
- B. It will discard the packet and send an ICMP Destination Unreachable message out interface FastEthernet 0/0.
- C. It will forward the packet out interface Serial 0/1 and send an ICMP Echo Reply message out interface serial 0/0.102.
- D. It will change the IP packet to an ARP frame and forward it out FastEthernet 0/0.
- E. It will forward the packet out the default route.
- F. None of the above.

Answer: B

Explanation:

The destination IP address of 192.168.22.3 is not in the routing table of the Corp router. Since there is no default route set, as shown by the "gateway of last resort is not set" statement, the packet will be dropped by the router and an ICMP Destination Unreachable message will be sent back to the source, which is Fast Ethernet 0/0 in this case.

QUESTION 354

You try to add a new router into the established Certkiller OSPF network. The networks attached to the new router do not appear in the routing tables of the other OSPF routers.

The new router was configured for OSPF in the following way:

```
Router(config)# router ospf 99
```

```
Router(config-if)# network 10.0.0.0 255.0.0.0 area 0
```

Based on this information, what is the most likely problem?

- A. The process id is configured improperly.
- B. The OSPF area is configured improperly.
- C. The network wildcard mask is configured improperly.
- D. The network number is configured improperly.
- E. The AS is configured improperly.
- F. The network subnet mask is configured improperly.
- G. All of the above are likely problems.

Answer: C

Explanation:

When configuring OSPF, the mask used for the network statement is a wildcard mask similar to an access list. In this specific example, the correct syntax would have been "network 10.0.0.0 0.0.0.255 area 0."

Incorrect Answers:

- A. Here the process ID is 99, which is valid.
- B. Area 0 is the backbone area, so configuring the network to be in area 0 should be acceptable.
- D. This is not the problem, assuming that all 10.X.X.X networks are to be configured for OSPF.
- E. The AS number, as called the process ID in OSPF is 99.
- F. OSPF uses wildcard masks, not the usual subnet masks

QUESTION 355

Which command will display all the EGRIP feasible successor routes known to a router?

- A. Router# show ip eigrp routes *
- B. Router# show ip eigrp summary
- C. Router# show ip eigrp topology
- D. Router# show ip eigrp adjacencies
- E. Router# show ip eigrp neighbors detail

Answer: C

Explanation:

The "show ip eigrp topology" command is used to display the entries in the EIGRP topology table. The topology table contains the feasible successors for each route, along with the feasible distance, each feasible successor's advertised distance to the route, and the locally calculated distance and cost to the destination.

QUESTION 356

Which IOS commands can a network technician use to verify all RIP, IGRP, EIGRP, and OSPF routing protocol configurations? Select two.

- A. debug ip routing
- B. show running-config
- C. show ip route protocols
- D. show ip protocols
- E. show protocols all

Answer: C, D

QUESTION 357

Exhibit

Certkiller3# show ip route

```
....output omitted....  
Gateway of last resort is 140.8.100.5 to network 0.0.0.0  
R 140.8.7.0/24 [120/3] via 150.8.12.9:00:00:20 serial 0/1  
O 140.8.5.5/24 [110/782] via 140.8.100.5, 00:38:34 serial 0/0  
R 140.8.78.8/29 [120/2] via 150.8.12.9 : 00:00:22 serial 0/1  
C 140.8.100.0/28 is directly connected, serial 0/0  
O 0.0.0.0/0 [110/2738] via 140.8.100.5:00:38:34 serial 0/0  
R 140.8.100.0/28 is directly connected, serial 0/0/ial 0/1  
O 0.0.0.0/0 [110/2738] via 140.8.100.5:00:38:34, serial 0/0
```

In the route highlighted in the graphic, what does the number 782 represent?

- A. Administrative distance
- B. delay to the destination
- C. cost of the route
- D. hop count

Answer: C

Explanation:

The exhibit Shows ospf is been used as the routing protocol and OSPF uses Cost. The cost (also called metric) of an interface in OSPF is an indication of the overhead required to send packets across a certain interface. The cost of an interface is inversely proportional to the bandwidth of that interface. A higher bandwidth indicates a lower cost.

QUESTION 358

Network topology exhibit

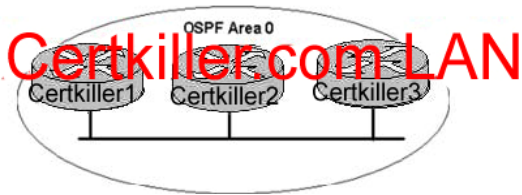

Certkiller 1 is unable to establish an OSPF neighbor relationship with Certkiller 3. What are possible reasons for this problem?(Choose Two).

- A. All of the routers need to be configured for backbone Area1.
- B. Certkiller 1 and Certkiller 2 are the DR and BDR, so OSPF will not establish neighbor adjacency with Certkiller 3
- C. A static route has been configured from Certkiller 1 to Certkiller 3 and prevents the neighbor adjacency from being established.
- D. The hello and dead interval timers are not set to the same values on Certkiller 1 and Certkiller 3.
- E. EIGRP is also configured on these routers with a lower administrative distance.
- F. Certkiller 1 and Certkiller 3 are configured in different areas.

Answer: D, F

QUESTION 359

Network topology exhibit

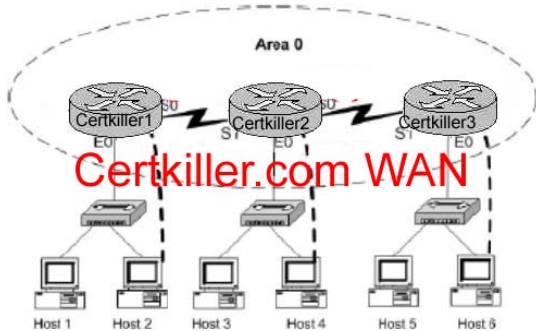

Certkiller .com has decided to network three locations to improve efficiency in inventory control. The routers have been named Certkiller 1, Certkiller 2, Certkiller 3. The necessary networking has been completed at each location, and the routers have been configured with single area OSPF as the routing protocol. The Certkiller 1 router was recently installed but connectivity is not complete because in incomplete routing tables. Identify and correct any problem you see in the configuration.

Note: The OSPF process must be configured to allow interfaces in specific subnets to participate in the routing process.

The IP address and passwords are listed in the chart.

LAB A

Name : Certkiller 1

E0 : 192.168.15.0 /24

S0 : 192.168.161.5 /30

Secret Password : Certkiller

LAB B

Name : Certkiller 2
E0 : 192.168.26.1 /24
S0 : 192.168.161.10 /30
S1 : 192.168.161.6 /30
Secret Password : Certkiller
LAB C

Name : Certkiller 3
E0 : 192.168.32.1 /24
S1 : 192.168.161.9 /30
Secret Password : Certkiller

Answer:

```
en
Certkiller
conf t
int eo
ip address 192.168.15.0 255.255.255.0
no shut
exit
int s0
ip address 192.168.161.5 255.255.255.252
no shut
exit
router ospf 1
network 192.168.15.0 0.0.0.255 area 0
network 192.168.161.4 0.0.0.3 area 0
exit
```

Copy run start

Note. Variation #1

LAB A

Name : Certkiller 1
E0 : 192.168.1.1 /24
S0 : 192.168.197.5 /30
Secret Password : Certkiller
LAB B

Name : Certkiller 2
E0 : 192.168.27.1 /24
S0 : 192.168.197.10 /30
S1 : 192.168.197.6 /30
Secret Password : Certkiller
LAB C

Name : Certkiller 3
E0 : 192.168.39.1 /24
S1 : 192.168.197.9 /30
Secret Password : Certkiller

Note. Variation #2

LAB A

Name : Certkiller 1
E0 : 192.168.12.1 /24
S0 : 192.168.172.5 /30
Secret Password : Certkiller

LAB B

Name : Certkiller 2
E0 : 192.168.17.1 /24
S0 : 192.168.172.10 /30
S1 : 192.168.172.6 /30
Secret Password : Certkiller

LAB C

Name : Certkiller 3
E0 : 192.168.36.1 /24
S1 : 192.168.172.9 /30
Secret Password : Certkiller

QUESTION 360

Network topology exhibit

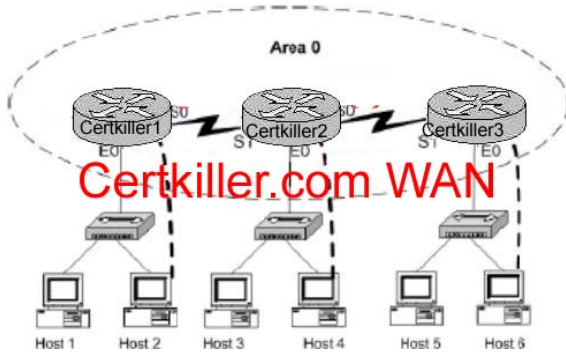

Certkiller .com has decided to network three locations to improve efficiency in inventory control. The routers have been named Certkiller 1, Certkiller 2, Certkiller 3. The necessary networking has been completed router was recently installed but connectivity is not complete because in incomplete routing tables. Identify and correct any problem you see in the configuration.

Note: The OSPF process must be configured to allow interfaces in specific subnets to participate in the routing process.

The IP address and passwords are listed in the chart.

LAB A

Name : Certkiller 1
E0 : 192.168.4.1 /24
S0 : 192.168.163.5 /30
Secret Password : Certkiller

LAB B

Name : Certkiller 2
E0 : 192.168.24.1 /24
S0 : 192.168.163.10 /30
S1 : 192.168.163.6 /30

Secret Password : Certkiller
LAB C
Name : Certkiller 3
E0 : 192.168.40.1 /24
S1 : 192.168.163.9 /30
Secret Password : Certkiller

Answer:
Certkiller 1
router ospf 1
network 192.168.4.0 000 255 area 0
network 192.168.63.4 0.0.0.3 area 0
Certkiller 2
Router ospf 2
network 192.168.163.8 0.0.0.3 area 0
network 192.168.163.4.0.0.0.3 area0
Certkiller 3
router ospf 3
network 192.168.40.0 0 0 0 255 area 0
network 192.168.163.8 0.0.0.3 area 0

QUESTION 361

Network topology exhibit

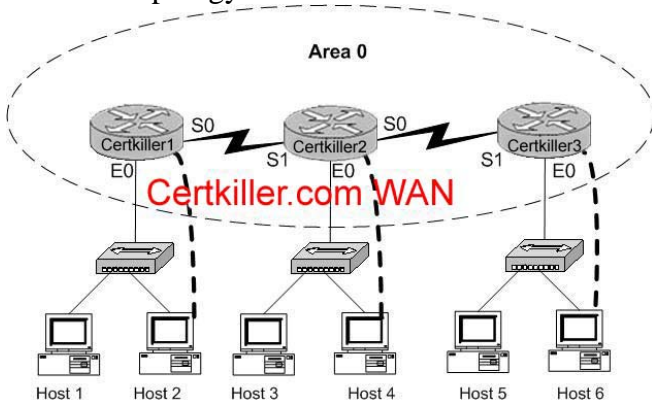

Certkiller .com has decided to network three locations to improve efficiency in inventory control. The routers have been named Certkiller 1, Certkiller 2, Certkiller 3. The necessary networking has been completed router was recently installed but connectivity is not complete because in incomplete routing tables. Identify and correct any problem you see in the configuration.
Note: The OSPF process must be configured to allow interfaces in specific subnets to participate in the routing process.
The IP address and passwords are listed in the chart.

LAB A
Name : Certkiller 1
E0 : 192.168.0.1 /24
S0 : 192.168.135.5 /30
Secret Password : Certkiller

LAB B

Name : Certkiller 2
E0 : 192.168.24.1 /24
S0 : 192.168.135.10 /30
S1 : 192.168.135.6 /30
Secret Password : Certkiller

LAB C

Name : Certkiller 3
E0 : 192.168.43.1 /24
S1 : 192.168.135.9 /30
Secret Password : Certkiller

Answer:

Full configuration 3 routers for working OSPF.

Certkiller 1:

```
conf t
int e0
ip addr 192.168.0.1 255.255.255.0
no shut
int s0
ip addr 192.168.135.5 255.255.255.252
no shut
ex
router ospf 1
network 192.168.0.0 0.0.0.255 area 1
network 192.168.135.0 0.0.0.255 area 1
end
```

Certkiller 2:

```
conf t
int e0
ip addr 192.168.24.1 255.255.255.0
no shut
int s0
ip addr 192.168.135.10 255.255.255.252
no shut
int s1
ip addr 192.168.135.6 255.255.255.252
no shut
ex
router ospf 1
network 192.168.24.0 0.0.0.255 area 1
network 192.168.135.0 0.0.0.255 area 1
end
```

Certkiller 3:

```
conf t
int e0
```

```
ip addr 192.168.43.1 255.255.255.0
no shut
int s1
ip addr 192.168.135.9 255.255.255.252
no shut
ex
router ospf 1
network 192.168.43.0 0.0.0.255 area 1
network 192.168.135.0 0.0.0.255 area 1
end
```

QUESTION 362

Certkiller .com has a large corporate network that uses multiple routing protocols. Hosts in a portion of the network that uses EIGRP have become unreachable. Which router command will allow you, the network technician, to view the status of these routes?

- A. Certkiller # show eigrp entries
- B. Certkiller # show protocols
- C. Certkiller # debug eigrp routes
- D. Certkiller # show ip route eigrp
- E. Certkiller # show route eigrp

Answer: D

Explanation:

The show ip route and show ip route eigrp commands both list the EIGRP-learned routes with a D beside them. D signifies EIGRP. The letter E was already being used for Exterior Gateway Protocol (EGP) when Cisco created EIGRP, so it chose the next closest letter to denote EIGRP-learned routes. You can see information about EIGRP neighbors with the show ip eigrp neighbors command, and the number of active neighbors (called peers in the command output) with the show ip eigrp interfaces command.

Reference: Cisco CCNA ICND 640-811 p.211

QUESTION 363

Exhibit, Network Topology

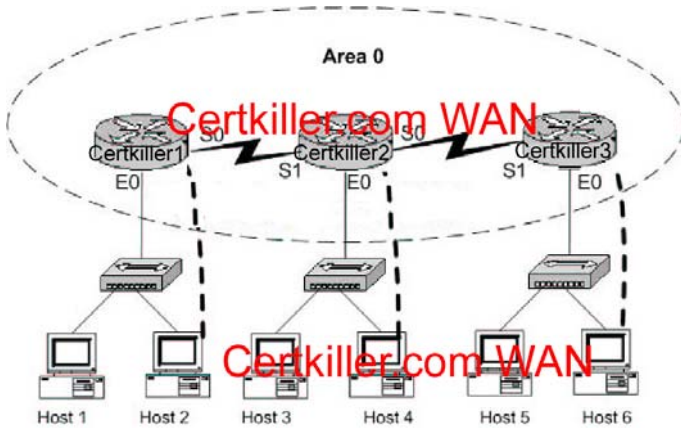

Certkiller .com has decided to network three locations to improve efficiency. The routers are named Certkiller 1, Certkiller 2, and Certkiller 3. The necessary networking has been completed at each location, and the routers have been configured with a single area OSPF as the routing protocol. The Certkiller 1 router was recently installed but connectivity is not complete because of incomplete routing tables. Identify and correct any problems you see in the configuration.

Be aware: The OSPF process must be configured to allow interfaces in specific subnets to participate in the routing process.

Certkiller 1

E0: 192.168.2.1/24

S0: 192.168.103.5/30

Secret Password: Certkiller

Certkiller 2

E0: 192.168.27.1/24

S0: 192.168.103.10/30

S1: 192.168.103.6/30

Secret Password: Certkiller

Certkiller 3

E0: 192.168.31.1/24

S0: 192.168.103.9/30

Secret Password: Certkiller

Simulation.

Answer:

Certkiller 1

Router ospf 1

Network 192.168.2.0 0.0.0.255

Network 192.168.103.4 0.0.0.3

Copy run start

Note, variation:

Certkiller 1

E0: 192.168.2.1/24

S0: 192.168.186.5/30

Secret Password: Certkiller

Certkiller 2

E0: 192.168.27.1/24
S0: 192.168.186.10/30
S1: 192.168.186.6/30
Secret Password: Certkiller
Certkiller 1
E0: 192.168.34.1/24
S0: 192.168.186.9/30
Secret Password: Certkiller

QUESTION 364

Exhibit

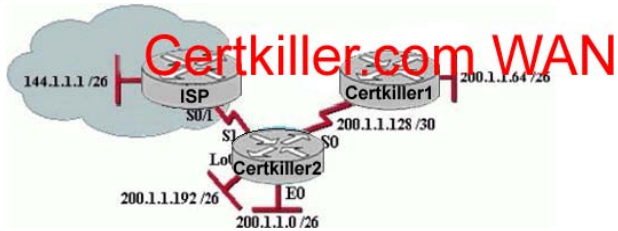

Exhibit #2

```
Gateway of last resort is 0.0.0.0 to network 0.0.0.0
200.1.1.0-24 is variably subnetted, 5 subnets, 3 masks
C    200.1.1.192/26 is directly connected, Loopback0
C    200.1.1.128/30 is directly connected, Serial0
D    200.1.1.64/26 [90/2195456] via 200.1.1.130, 00:02:15, Serial0
D    200.1.1.0/24 is a summary, 00:00:41, Null0
C    200.1.1.0/26 is directly connected, Ethernet0
200.1.2.0/30 is subnetted, 1 subnets
C    200.1.2.4 is directly connected, Serial1
S*  0.0.0.0/0 is directly connected, Serial1
```

What can be determined from the router output displayed in the exhibit?

- A. 200.1.1.64 is a default route.
- B. The output shows that there are three default routes.
- C. The output came from router Certkiller 2.
- D. The output came from a router that has four physical interfaces.
- E. EIGRP is in use in this network.

Answer: E

Explanation:

In the routing table the "D" letter marks the route learned from EIGRP routing protocol.

QUESTION 365

Exhibit, Network Topology

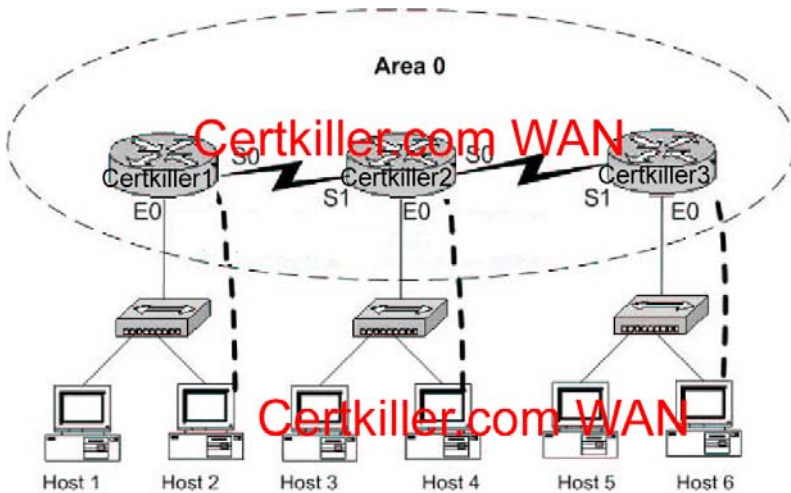

Certkiller .com has decided to network three locations to improve efficiency. The routers are named Certkiller 1, Certkiller 2, and Certkiller 3. The necessary networking has been completed at each location, and the routers have been configured with a single area OSPF as the routing protocol. The Certkiller 3 router was recently installed but connectivity is not complete because of incomplete routing tables. Identify and correct any problems you see in the configuration.

Be aware: The OSPF process must be configured to allow interfaces in specific subnets to participate in the routing process.

Certkiller 1

E0: 192.168.2.1/24

S0: 192.168.144.5/30

Secret Password: Certkiller

Certkiller 2

E0: 192.168.19.1/24

S0: 192.168.144.10/30

S1: 192.168.144.6/30

Secret Password: Certkiller

Certkiller 3

E0: 192.168.144.1/24

S0: 192.168.144.9/30

Secret Password: Certkiller

Simulation.

Answer:

Certkiller 3

Conf t

Router ospf 1

Network 192.168.144.0 0.0.0.255

Network 192.168.144.8 0.0.0.3

Exit

Copy run start

QUESTION 366

```

CK1: Ethernet0 is up, line protocol is up
      Internet address 192.168.1.2/24, Area 0
      Process ID 1, Router ID 192.168.31.33, Network Type BROADCAST, Cost: 10
      Transmit Delay is 1 sec, State DR, Priority 1
      Designated Router (ID) 192.168.31.33, Interface address 192.168.1.2
      No backup designated router on this interface, Network
      Timer intervals configured, Hello 5, Dead 20, Wait 20, Retransmit 5

CK2: Ethernet0 is up, line protocol is up
      Internet address 192.168.1.1/24, Area 0
      Process ID 2, Router ID 192.168.31.11, Network Type BROADCAST, Cost: 10
      Transmit Delay is 1 sec, State DR, Priority 1
      Designated Router (ID) 192.168.31.33, Interface address 192.168.1.1
      No backup designated router on this interface, Network
      Timer intervals configured, Hello 10, Dead 40, Wait 40, Retransmit 5

```

A network administrator is troubleshooting the OSPF configuration of routers CK1 and CK2. The routers cannot establish an adjacency relationship on their common Ethernet link. The graphic shows the output of the show ip ospf interface e0 command for routers CK1 and CK2. Based on the information in the graphic, what is the cause of this problem?

- A. The OSPF area is not configured properly.
- B. The priority on CK1 should be set higher.
- C. The cost on CK1 should be set higher.
- D. The hello and dead timers are not configured properly.
- E. A backup designated router needs to be added to the network.
- F. The OSPF process ID numbers must match.

Answer: D

QUESTION 367

Exhibit

Certkiller A #show ip ospf neighbor

Neighbor ID	PRI	State	Dead Time	Address	Interface
192.168.1.2	1	Full/-	00:00:37	192.168.1.2	Serial1

Which type of OSPF network will provide the output shown in the graphic?

- A. FDDI
- B. nonbroadcast multicast
- C. broadcast multi-access
- D. point-to-point

Answer: D

Certkiller A# show ip ospf neighbor

Neighbor ID	Pri	State	Dead Time	Address
2.2.2.2	1	FULL/ -	00:00:37	2.2.2.2

Serial0

Certkiller A# show ip ospf interface serial 0

```

Serial0 is up, line protocol is up
Internet Address 0.0.0.0/24, Area 0

```

Process ID 1, Router ID 3.3.3.3, Network Type POINT_TO_POINT,
Cost: 64
Transmit Delay is 1 sec, State POINT_TO_POINT,
Timer intervals configured, Hello 10, Dead 40, Wait 40,
Retransmit 5
Hello due in 00:00:08
Index 2/2, flood queue length 0
Next 0x0(0)/0x0(0)
Last flood scan length is 1, maximum is 1
Last flood scan time is 0 msec, maximum is 0 msec
Neighbor Count is 1, Adjacent neighbor count is 1
Adjacent with neighbor 2.2.2.2
Suppress hello for 0 neighbor(s)
Reference:
[Http://www.cisco.com/en/US/tech/ CK3 65/technologies_configuration_example09186a0080094057.shtml](http://www.cisco.com/en/US/tech/CK365/technologies_configuration_example09186a0080094057.shtml)

QUESTION 368

While logged into a router, you wish to see the RIP routing updates in real time as they are sent and received. Which command would you issue to see these updates?

- A. Show ip protocols
- B. Show ip route rip
- C. Debug ip rip
- D. Debug ip updates
- E. Debug ip transactions

Answer: C

Explanation:

The command debug ip rip will display routing updates as they are sent and received by a router.

Incorrect Answers:

- A. This command will show the routing protocols that the router is using, but it will not show anything in real time. All show commands take a snapshot of what the router is doing at that given time.
 - B. This will provide all of the routes that have been learned by the router via RIP, but it will not show the updates in real time.
 - D, E. These are invalid commands.
-

QUESTION 369

You are configuring a brand new router for the first time. In doing so, you log into the router via a console cable and then copy and paste the configuration from a notepad document. After this, the configuration appears as follows:

```
hostname CertkillerA
!
!
interface Ethernet0
 ip address 192.168.10.9 255.255.255.248
!
interface Serial0
 ip address 172.16.25.1 255.255.255.0
 clockrate 56000
!
interface Serial1
 ip address 10.1.1.1 255.255.255.0
!
router rip
 network 192.168.10.0
!
line con 0
 password CertkillerA
 login
line aux 0
line vty 0 4
 password CertkillerA
 login
end
```

Host 192.168.10.10/29 can't ping the Ethernet interface of the router after the router is installed into the network. Why? (Select only one answer choice)

- A. The new configuration must be saved to the NVRAM before the changes can be effected.
- B. The subnet mask on the router results in miscommunication.
- C. The Ethernet network does not feature in the routing table due to incomplete RIP configuration.
- D. The copied configuration did not overwrite the shutdown command on the Ethernet interface.
- E. The router needs to be rebooted before the changes are effected.

Answer: D

Explanation:

Default configuration of any interface is always shutdown and always needs the command "no shutdown" in the interface command mode in order to enable the interface.

Reference:

CCNA Self-Study CCNA INTRO exam certification Guide (Cisco Press, ISBN 1-58720-094-5) Page 379

QUESTION 370

The Certkiller HQ and branch office locations are set up as shown in the diagram below:

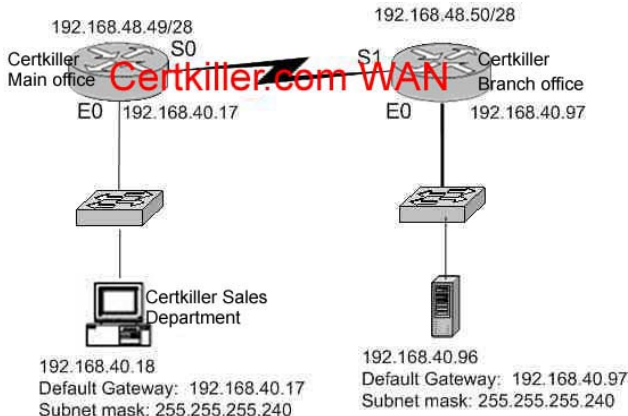

Hosts from the sales department are unable to access the new branch office server that was recently installed. Based on the exhibit above, what is the underlying cause of this problem?

- A. The default gateway in the sales department is inaccurate.
- B. The serial 0 interface on the Main Office router and the serial 1 interface on the Branch Office router are not compatible.
- C. The subnet mask of the workstations in the sales department is inaccurate.
- D. The host address of the server at the Branch Office is invalid.
- E. The default gateway of the server at the Branch Office is inaccurate.
- F. None of the above

Answer: D

Explanation: The host address is incorrectly a network address.
Incorrect Answers:

- A. The default gateway in the sales department is correct.
- B. This is no problem here.
- C. The subnet mask is correct.
- E. The default gateway in the branch office is correct.

Reference: Steve McQuerry, "Interconnecting Cisco Network Devices" (Cisco Press: 2000) pages 233 - 234.

QUESTION 371

The new Certkiller location is displayed below:

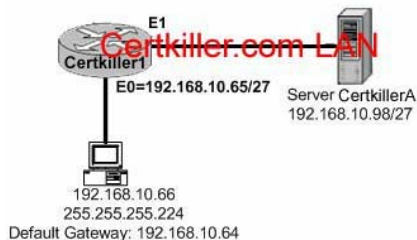

A new PC is installed on the LAN of the Certkiller 1 router as shown above. This PC is unable to connect to the Certkiller A server located on the Ethernet 1 network.

What is the cause of this?

- A. IP address of the Ethernet 0 router interface is wrong
- B. Server is using an invalid IP address
- C. Workstation default gateway is set incorrectly
- D. Workstation subnet mask is incorrect
- E. Workstation IP address is invalid

Answer: C

Explanation:

The default gateway of the host (192.168.10.64) is wrong. 192.168.10.64 is the network address of the host's network in this question. The default gateway should be the address of the local interface of the router. In this case: 192.168.10.65.

Incorrect Answers:

- A: The IP address of the Eternet0 interface is valid.
- B: The IP address of the server is valid.
- D: The network uses a 27 bit subnet mask which equates to 255.255.255.224.
- E: The IP host address 192.168.10.66 is a valid host address on the subnet.

QUESTION 372

A new LAN is being implemented on the Certkiller 1 network as shown below:

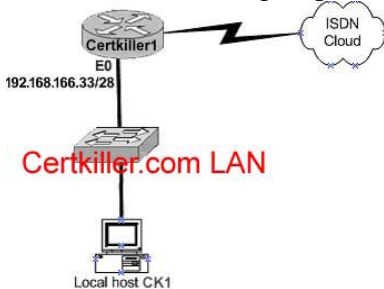

The local host CK1 can't access any of the resources on the other networks. The configuration of CK1 is as follows:

host address:192.168.166.45

subnet mask:255.255.255.240

default gateway: ..192.168.166.32

What is the underlying cause of this problem?

- A. The default gateway is a network address.
- B. The default gateway is on a different subnet address as the host.
- C. The IP address of the host is on a different subnet.
- D. The host subnet mask is incompatible to the subnet mask of the attached router interface.

Answer: A

Explanation:

The range of the subnet used in this question is 192.168.166.32 to 192.168.166.47.

192.168.166.32 is the network address and 192.168.166.47 is the broadcast. This leaves the usable host address range of 192.168.166.33 to 192.168.166.46.

The default gateway for the host should be 192.168.166.33.

Incorrect Answers:

B: The default gateway is on the same network but it is a network address.

C: The host address is correct.

D: The subnet mask 255.255.255.240 uses 28 bits and is therefore correct.

QUESTION 373

You're working at Certkiller as a network administrator when your MCSE assistant calls you for help. He has attempted to configure Router CK1 and incorrectly configured the router interface with a subnet broadcast address. You have to correct this by first removing the incorrect IP address and then re-entering the first usable IP address of the same subnet.

How will you do this?

A. CK1 (config-if)# no ip address 190.160.45.31 255.255.255.240

CK1 (config-if)# ip address 190.160.45.17 255.255.255.240

B. CK1 (config-if)# no ip address 190.160.45.23 255.255.255.252

CK1 (config-if)# ip address 190.160.4.21 255.255.255.252

C. CK1 (config-if)# no ip address 190.160.45.23 255.255.255.240

CK1 (config-if)# ip address 190.160.45.20 255.255.255.240

D. CK1 (config-if)# clear ip address 190.160.45.23

255.255.255.0

CK1 (config-if)# no address 190.160.45.17 255.255.255.0

E. CK1 (config-if)# no ip address 190.160.45.15 255.255.255.252

CK1 (config-if)# ip address 190.160.45.9 255.255.255.252

Answer: A

Explanation:

To set a primary or secondary IP address for an interface, use the ip address interface configuration command. To remove an IP address or disable IP processing, use the no form of this command.

Current Host Range = 190. 160. 45. 17 to 190. 160. 45. 30

Incorrect Answers:

B, C, E. These are all invalid IP address combinations, given that the broadcast address and the first usable IP address combinations do not match.

D. The "clear" command is invalid. To erase a configuration statement, simply add the keyword "no" to the beginning of the configuration statement.

QUESTION 374

Part of the configuration files for routers Certkiller 1 and Certkiller 2 are displayed below:

hostname Certkiller 1

hostname Certkiller 2

!

!

640-801

```
username Certkiller 2 password king      username Certkiller 1 password king
!  
interface serial 0                       interface serial 0  
ip address 12.3.6.2 255.255.0.0         ip address 12.3.6.3 255.255.0.0  
encapsulation ppp                       encapsulation ppp  
clockrate 56000                         ppp authentication chap
```

If you were to enter the "show interface serial 0" command on router Certkiller 1, which of the following will be displayed? (Choose two)

- A. Serial 0 is down, line protocol is down
- B. Serial 0 is up, line protocol is up
- C. Open: IPCP, CDPCP
- D. LCP closed
- E. LCP open

Answer: B, E

Explanation:

Even though CHAP is only configured on one end of the link, the physical serial interfaces will be up, line protocol up since the encapsulations match with PPP on each end, and the clock rate is set on the DCE end. LCP will be open, since the username and password statements are correctly configured for the PPP CHAP authentication.

QUESTION 375

While troubleshooting a connectivity issue from a PC you obtain the following information:

Local PC IP address: 190.0.3.35/24

Default Gateway: 190.0.3.1

Remote Server: 190.0.5.250/24

You then conduct the following tests from the local PC:

Ping 127.0.0.1 - Unsuccessful

Ping 190.0.3.35 - Successful

Ping 190.0.3.1 - Unsuccessful

Ping 190.0.5.250 - Unsuccessful

What is the underlying cause of this problem?

- A. TCP/IP not correctly installed
- B. Local physical layer problem
- C. NIC not functioning
- D. Remote physical layer problem

Answer: A

Explanation:

Every Windows based PC uses the 127.0.0.1 as the local loopback IP address. Every PC will respond to this local IP address if the TCP/IP stack is correctly installed and running

on the machine. If you cannot ping the loopback address of 127.0.0.1, then something is wrong with the TCP/IP protocol stack.

QUESTION 376

While troubleshooting connectivity issues, you log into a remote router. From there, you wish to see the layer 1 and layer 2 status of the interface. Which of the following IOS commands would you issue to check the current IP addressing, as well as the layer 1 and layer 2 status of an interface? (Select three answer choices)

- A. CK1 # show version
- B. CK1 # show protocols
- C. CK1 # show interfaces
- D. CK1 # show controllers
- E. CK1 # show ip interface
- F. CK1 # show startup-config

Answer: C, D, E

Explanation:

show interfaces is used to see the IP addresses and layer 2 information configured on the interfaces.

show controllers is used to see the layer 1 statistics. It tells about the V.35 cables whether they are physically attached or not.

show ip interfaces is used to see the IP addresses configured on the interfaces.

Incorrect Answers:

- A. This will show IOS information and hardware information on the router, but will not show any individual interface information.
- B. This will show the layer 3 and layer 4 protocols running on the interface, but it will not provide any information on layer one or two.
- F. This will only show the information pertaining to the configuration file that is saved in NVRAM.

QUESTION 377

A local chain of bike shops wants to centralize their business administration and connect their three computer networks together. To do this, the network was set up with 3 routers, which were configured as shown below:

- The routers are named: Certkiller 1, Certkiller 2, and Certkiller 3, respectively.
- They are all using RIP as the routing protocol
- The serial 0 interfaces are responsible for clocking
- The password for all three routers is " Certkiller "
- All three routers are using their default subnet mask.
- The IP addresses are as listed below.

You need to figure out what's causing the miscommunication and make whatever changes are necessary to establish connectivity between the three shops. Click on the correct part of the network below, and make the necessary changes in the

configuration.

Certkiller 1

E0 192.168.27.1

E1 192.168.29.1

S0 192.168.31.1

Secret password: Certkiller

Certkiller 2

E0 192.168.35.1

S0 192.168.33.1

S1 192.168.31.2

Secret password: Certkiller

Certkiller 3

E0 192.168.37.1

S1 192.168.33.2

Secret password: Certkiller

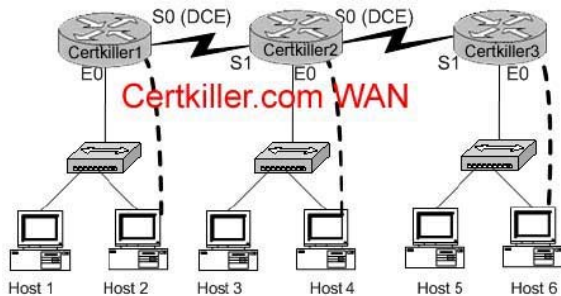

To configure the router you need to click on the host icon that is connected to the router by a serial cable.

Answer:

Click on Host 2:

Router Certkiller 1:

Certkiller 1 > enable

Password: Certkiller

Certkiller 1 # config terminal

Certkiller 1 (config) # interface ethernet 0

Certkiller 1 (config-if) # ip address 192.168.27.1 255.255.255.0

Certkiller 1 (config-if) # no shutdown

Certkiller 1 (config-if) # exit

Certkiller 1 (config) # interface ethernet 1

Certkiller 1 (config-if) # ip address 192.168.29.1 255.255.255.0

Certkiller 1 (config-if) # no shutdown

Certkiller 1 (config-if) # exit

Certkiller 1 (config) # interface serial 0

Certkiller 1 (config-if) # ip address 192.168.31.1 255.255.255.0

Certkiller 3 (config-if) # clock rate 64000

Certkiller 1 (config-if) # no shutdown

Certkiller 1 (config-if) # exit

Certkiller 1 (config) # router rip

```
Certkiller 1 (config-router) # network 192.168.27.0
Certkiller 1 (config-router) # network 192.168.29.0
Certkiller 1 (config-router) # network 192.168.31.0
Certkiller 1 (config-router) # Ctrl-Z
Certkiller 1 # copy running-config startup-config
Click on Host 4
Router Certkiller 2:
Certkiller 2> enable
Password: Certkiller
Certkiller 2 # config t
Certkiller 2 (config) # interface ethernet 0
Certkiller 2 (config-if) # ip address 192.168.35.1 255.255.255.0
Certkiller 2 (config-if) # no shutdown
Certkiller 2 (config-if) # exit
Certkiller 2 (config) # interface serial 0
Certkiller 2 (config-if) # ip address 192.168.33.1 255.255.255.0
Certkiller 2 (config-if) # clock rate 64000
Certkiller 2 (config-if) # no shutdown
Certkiller 2 (config-if) # exit
Certkiller 2 (config) # interface serial 1
Certkiller 2 (config-if) # ip address 192.168.31.2 255.255.255.0
Certkiller 2 (config-if) # no shutdown
Certkiller 2 (config-if) # exit
Certkiller 2 (config) # router rip
Certkiller 2 (config-router) # network 192.168.35.0
Certkiller 2 (config-router) # network 192.168.33.0
Certkiller 2 (config-router) # network 192.168.31.0
Certkiller 2 (config-router) # Ctrl-Z
Certkiller 2 # copy running-config startup-config
Router Certkiller 3:
Click on Host6
Certkiller 3> enable
Password: Certkiller
Certkiller 3 # config t
Certkiller 3 (config) # interface ethernet 0
Certkiller 3 (config-if) # ip address 192.168.37.1 255.255.255.0
Certkiller 3 (config-if) # no shutdown
Certkiller 3 (config-if) # exit
Certkiller 3 (config) # interface serial 1
Certkiller 3 (config-if) # ip address 192.168.33.2 255.255.255.0
Certkiller 3 (config-if) # no shutdown
Certkiller 3 (config-if) # exit
Certkiller 3 (config) # router rip
Certkiller 3 (config-router) # network 192.168.33.0
Certkiller 3 (config-router) # network 192.168.37.0
```

Certkiller 3 (config-router) # Ctrl-Z
Certkiller 3 # copy running-config startup-config

QUESTION 378

The Certkiller .com network has three different sites with one router at each site. The routers are named Certkiller 1, Certkiller 2, and Certkiller 3. An assistant technician has configured all the routers, but no connectivity exists between the routers. Your task is to identify all error(s) and make the necessary adjustment(s) to establish network connectivity.

The routers have been configured with the following configuration:

- They are named Certkiller 1, Certkiller 2, and Certkiller 3.
- RIP is the routing protocol
- Clocking is provided on the serial 0 interface.
- The password on each router is " Certkiller "
- The subnet mask on all interfaces is the default subnet mask.
- The IP addresses are listed in the chart below.

Certkiller 1

E0 192.168.3.1

S0 192.168.5.1

Certkiller 2

E0 192.168.8.1

S0 192.168.11.1

S1 192.168.5.2

Certkiller 3

E0 192.168.13.2

S1 192.168.11.2

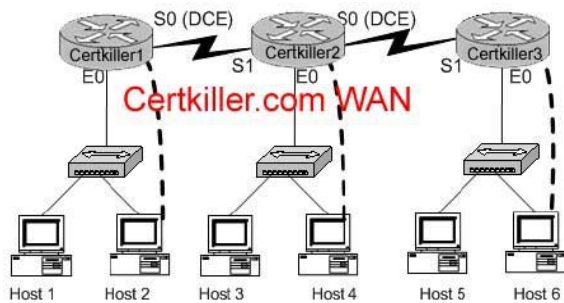

To configure the router click on a host icon that is connected to the router by a serial console cable.

Answer:

Note: The following solutions are complete. It might not be necessary to configure everything.

Click on Host 2:

Router Certkiller 1:

Certkiller 1> enable

Password: Certkiller

Certkiller 1 # config terminal

Certkiller 1 (config) # interface ethernet 0

```
Certkiller 1 (config-if) # ip address 192.168.3.1 255.255.255.0
Certkiller 1 (config-if) # no shutdown
Certkiller 1 (config-if) # exit
Certkiller 1 (config) # interface serial 0
Certkiller 1 (config-if) # ip address 192.168.5.1 255.255.255.0
Certkiller 1 (config-if) # clock rate 64000
Certkiller 1 (config-if) # no shutdown
Certkiller 1 (config-if) # exit
Certkiller 1 (config) # router rip
Certkiller 1 (config-router) # network 192.168.3.0
Certkiller 1 (config-router) # network 192.168.5.0
Certkiller 1 (config-router) # Ctrl-Z
Certkiller 1 # copy running-config startup-config
```

Click on Host 4

Router Certkiller 2:

```
Certkiller 2> enable
Password: Certkiller
Certkiller 2 # config t
Certkiller 2 (config) # interface ethernet 0
Certkiller 2 (config-if) # ip address 192.168.8.1 255.255.255.0
Certkiller 2 (config-if) # no shutdown
Certkiller 2 (config-if) # exit
Certkiller 2 (config) # interface serial 0
Certkiller 2 (config-if) # ip address 192.168.11.1 255.255.255.0
Certkiller 2 (config-if) # clock rate 64000
Certkiller 2 (config-if) # no shutdown
Certkiller 2 (config-if) # exit
Certkiller 2 (config) # interface serial 1
Certkiller 2 (config-if) # ip address 192.168.5.2 255.255.255.0
Certkiller 2 (config-if) # no shutdown
Certkiller 2 (config-if) # exit
Certkiller 2 (config) # router rip
Certkiller 2 (config-router) # network 192.168.8.0
Certkiller 2 (config-router) # network 192.168.11.0
Certkiller 2 (config-router) # network 192.168.5.0
Certkiller 2 (config-router) # Ctrl-Z
Certkiller 2 # copy running-config startup-config
```

Router Certkiller 3:

Click on Host F

```
Certkiller 3> enable
Password: Certkiller
Certkiller 3 # config t
Certkiller 3 (config) # interface ethernet 0
Certkiller 3 (config-if) # ip address 192.168.13.2 255.255.255.0
Certkiller 3 (config-if) # no shutdown
Certkiller 3 (config-if) # exit
```

```
Certkiller 3 (config) # interface serial 1
Certkiller 3 (config-if) # ip address 192.168.11.2 255.255.255.0
Certkiller 3 (config-if) # clock rate 64000
Certkiller 3 (config-if) # no shutdown
Certkiller 3 (config-if) # exit
Certkiller 3 (config) # router rip
Certkiller 3 (config-router) # network 192.168.13.0
Certkiller 3 (config-router) # network 192.168.11.0
Certkiller 3 (config-router) # Ctrl-Z
Certkiller 3 # copy running-config startup-config
```

QUESTION 379

Your task is to troubleshoot some issues with the existing Certkiller network. The previous network administrator tried to build a network by connecting three routers together, but the routing tables aren't being updated properly.

- There are three routers named Certkiller 1, Certkiller 2, and Certkiller 3 respectively.
- Certkiller 2 and Certkiller 3 are configured perfectly and completely operational.
- The entire networks falls within a single OSPF area

Your goal is to locate and fix this router configuration problem.

Current configuration:

Certkiller 1

E0: 192.168.33.1/24

S0: 192.168.100.5/30

Secret Password: Certkiller

Certkiller 2

E0: 192.168.34.1/24

S0: 192.168.100.10/30

S1: 192.168.100.6/30

Secret Password: Certkiller

Certkiller 3

E0: 192.168.35.1/24

S1: 192.168.100.9/30

Secret Password: Certkiller

Click on the picture of host connected to a router by a serial console cable.

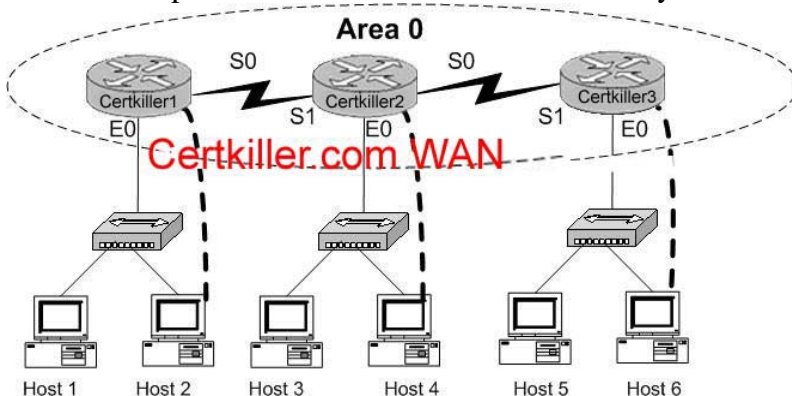

Answer:

```
Certkiller 1#config t
Certkiller 1(config)#no router ospf 2
Certkiller 1(config)#^Z
Certkiller 1#show ip ospf
Certkiller 1#config t
Certkiller 1(config)#router ospf 2
Certkiller 1(config)#network 192.168.33.0 0.0.0.255 area 0
Certkiller 1(config)#network 192.168.100.4 0.0.0.3 area 0
Certkiller 1(config)#^Z
Certkiller 1#show ip route
Certkiller 1#copy running startup
```

QUESTION 380

The Certkiller network consists of three routers as shown in the diagram below. All three routers are connected serially, and all links are up and running properly. The Certkiller network is using OSPF as the routing protocol, and all routers are contained in area 0.

Recently, some router configuration changes were made, and some routing issues have occurred as a result. The router information and configurations are shown below:

- The three routers: Certkiller 1, Certkiller 2, and Certkiller 3 are connected by their serially and their links are good.
- The routing protocol is OSPF
- There's only one OSPF area (area 0)

Locate the configuration problem and reconfigure it correctly:

These are the current configurations:

Certkiller 1

E0: 192.168.3.1/24

S0: 172.16.10.5/30

Secret password: Certkiller

Certkiller 2

E0: 192.168.4.1/24

S0: 172.16.10.10/30

S1: 172.16.10.6/30

Secret password: Certkiller

Certkiller 3

E0: 192.168.5.1/24

S1: 172.16.10.9/30

Secret password: Certkiller

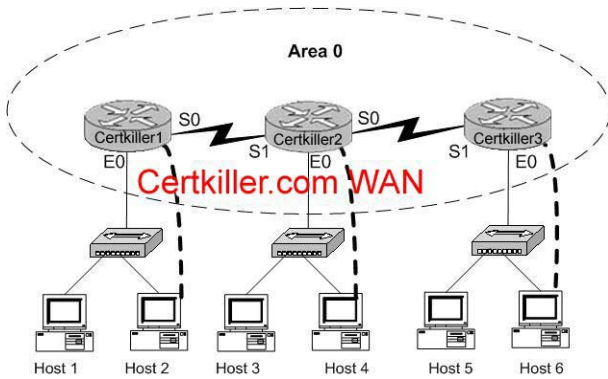

Answer:

```

Certkiller 2#config
Certkiller 2(config)#no router ospf 2
Certkiller 2(config)#router ospf 2
Certkiller 2(config-router)#network 192.168.4.0 0.0.0.255 area 0
Certkiller 2(config-router)#network 172.16.10.8 0.0.0.3 area 0
Certkiller 2(config-router)#network 172.16.10.4 0.0.0.3 area 0
Certkiller 2(config-router)#Ctrl-Z
Certkiller 2#copy running start

```

QUESTION 381

Network topology exhibit



A Cisco router Certkiller 2 and a Catalyst Switch Certkiller switch are connected as shown in the exhibit. The Certkiller .com technician is working on a computer that is connected to the management console of the switch. In order to configure the default gateway for the switch, the technician needs to learn the IP address of the attached router interface.

Which IOS command will provide this information in the absence of Layer 3 connectivity?

- A. ping router_ip_address
- B. ping switchr_ip_address
- C. show ip rarp
- D. show cdp neighbors detail
- E. show ip neighbors
- F. show dhcp-config

Answer: D

Explanation:

Show cdp neighbor detail command can be issued on the router or the switch. This command shows the information about all attached devices.

QUESTION 382

Network topology exhibit.



The Ethernet networks connect to router Certkiller 1 in the exhibit have been summarized for router Certkiller 2 as 192.1.144.0/20. Which of the following packet destination addresses will Certkiller 2 forward to Certkiller 1, according to this summary? Select two.

- A. 192.1.159.2
- B. 192.1.160.11
- C. 192.1.138.41
- D. 192.1.151.254
- E. 192.1.143.145
- F. 192.1.1.144

Answer: A, D

Explanation:

To be a part of the advertised summary route, the addresses should have first 20 bit the same as 192.1.144.0. Since first 16 are the same for all, lets check just 4 bits from the 3rd octet for all of them:

Summary route: 1001

- A: 1001
- B:1010
- C:1000
- D:1001
- E:1000
- F:0000

QUESTION 383

Exhibit

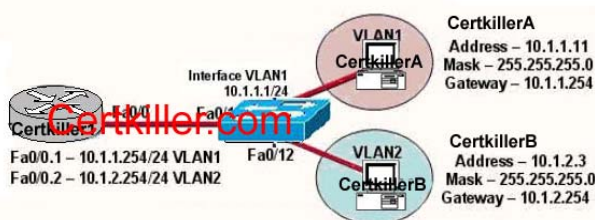

The network shown in the exhibit is experiencing connectivity problems. Which of

the following will correct the problems? Select two.

- A. Configure the gateway on Certkiller A as 10.1.1.1.
- B. Configure the gateway on Certkiller B as 10.1.2.254.
- C. Configure the IP address of Certkiller A as 10.1.2.2.
- D. Configure the IP address of Certkiller B as 10.1.2.2.
- E. Configure the masks on both hosts to be 255.255.255.224.
- F. Configure the masks on both hosts to be 255.255.255.240.

Answer: B, D

QUESTION 384

The Certkiller router is running RIP as the routing protocol, and the IP routing table is displayed below:

Gateway of last resort is 10.1.2.2 to network 0.0.0.0

10.0.0.0/24 is subnetted, 2 subnets

R 10.1.3.0 [120/1] via 10.1.2.2, 00:00:00, Serial0/0

C 10.1.2.0 is directly connected, Serial0/0

C 10.1.5.0 is directly connected, Serial0/1

C 10.1.6.0 is directly connected, FastEthernet0/0

R* 0.0.0.0/0 [120/1] via 10.1.5.5, 00:00:00, Serial0/1

Based on the output above, if an administrator pings host 10.1.8.5 from host 10.1.6.100, how will the router Certkiller A process the ICMP packets?

- A. The packets will be discarded.
- B. The packets will be routed out the S0/0 interface.
- C. The packets will be routed out the S0/1 interface.
- D. The packets will be routed out the Fa0/0 interface.
- E. The packets will be routed through the 10.1.2.2 gateway.

Answer: C

Explanation:

Since 10.1.8.5 is not located in the routing table, the default gateway will be used to forward the ICMP packet. The default gateway is learned via RIP, with the next hop IP address of 10.1.5.5. This default gateway router lies on the serial 0/1 interface.

Additional Info:

Gateways of last resort selected using the ip default-network command are propagated differently depending on which routing protocol is propagating the default route. For IGRP and EIGRP to propagate the route, the network specified by the ip default-network command must be known to IGRP or EIGRP. This means the network must be an IGRP- or EIGRP-derived network in the routing table, or the static route used to generate the route to the network must be redistributed into IGRP or EIGRP, or advertised into these protocols using the network command.

RIP advertises a route to 0.0.0.0 if a gateway of last resort is selected using the ip default-network command. This network specified in the ip default-network command

need not be explicitly advertised under RIP. For example, note that the gateway of last resort on this router was learned using the combination of the ip route and ip defaultnetwork commands. If you enable RIP on this router, RIP advertises a route to 0.0.0.0 (although not to the Ethernet0 network because of split-horizon):

```
2513(config)#router rip
2513(config-router)#network 161.44.0.0
2513(config-router)#network 131.108.0.0
2513(config-router)#^Z
2513#
%SYS-5-CONFIG_I: Configured from console by console
2513#debug ip rip
*Mar 2 07:39:35.504: RIP: sending v1 update to 255.255.255.255 via Ethernet0
(161.44.192.1)
*Mar 2 07:39:35.508: RIP: build update entries
*Mar 2 07:39:35.508: network 131.108.0.0 metric 1
*Mar 2 07:39:35.512: RIP: sending v1 update to 255.255.255.255 via Serial0
(131.108.99.1)
*Mar 2 07:39:35.516: RIP: build update entries
*Mar 2 07:39:35.520: subnet 0.0.0.0 metric 1
*Mar 2 07:39:35.524: network 161.44.0.0 metric 1
ip route 0.0.0.0 0.0.0.0
```

Creating a static route to network 0.0.0.0 0.0.0.0 is another way to set the gateway of last resort on a router. As with the ip default-network command, using the static route to 0.0.0.0 is not dependent on any routing protocols. However, ip routing must be enabled on the router.

In earlier versions of RIP, the default route created using the ip route 0.0.0.0 0.0.0.0 was automatically advertised by RIP routers. In Cisco IOS Software Release 12.0T and later, RIP does not advertise the default route if the route is not learned via RIP. It may be necessary to redistribute the route into RIP.

QUESTION 385

The topology of the Certkiller network is displayed below, along with the routing table of the Certkiller 1 router:

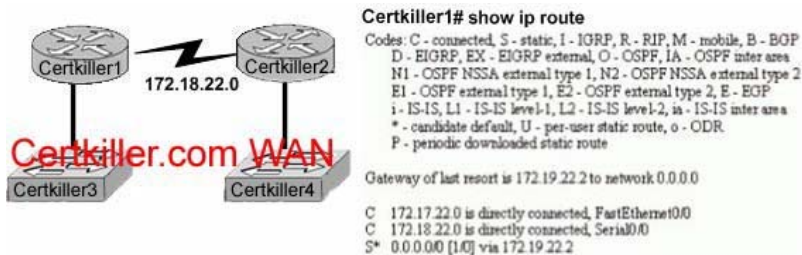

172.17.22.0 172.31.5.0

Changes to the Certkiller network were made, and now users on the Certkiller 3 LAN are not able to connect to the Certkiller 4 LAN. Based on the information above, what could be the reason for this?

A. The FastEthernet interface is disabled.

- B. The neighbor relationship table is not updated.
- C. A static route is configured incorrectly.
- D. The routing table on Certkiller 1 is not updated.
- E. IP routing is not enabled.

Answer: C

Explanation:

On the bottom line of the command output for 'show ip route' you can see that there is an asterisk by the letter S. The S stands for static route, and the static route is incorrectly configured.

Incorrect Answers:

- A. If this were true, then the users on the LAN would be unable to connect to anything outside of their own network.
- B. It appears that only a single static route is being used on the Certkiller 1 router. Neighbors do not need to be established for static routes.
- D. The routing table consists of a single static route, which is configured incorrectly. The routing tables do not become updated dynamically when static routes are used.
- E. This is not true, as a static route has been configured.

QUESTION 386

A point to point leased line connecting routers Certkiller 1 and Certkiller 2 is installed as shown below:

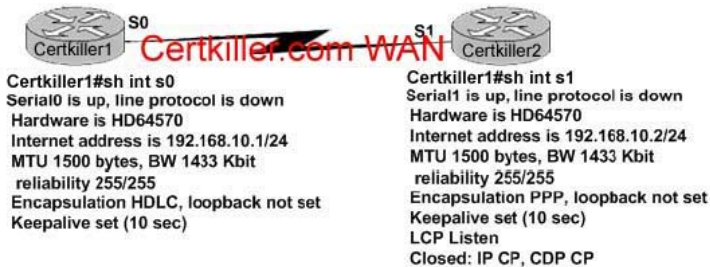

The two serially connected routers can't communicate. Can you identify the fault on router Certkiller 2?

- A. Link reliability is insufficient
- B. IPCP is not open
- C. Incorrect subnet mask
- D. Incompatible encapsulation
- E. Bandwidth allocation is too low
- F. Incomplete IP address

Answer: D

Explanation:

HDLC and PPP configuration is straightforward. You just need to be sure to configure the same WAN data-link protocol on each end of the serial link. Otherwise, the routers

will misinterpret the incoming frames, because each WAN data-link protocol uses a different frame format. The routers must match at each end of the private leased line link.
Reference: CCNA Self-Study CCNA ICND exam certification Guide (Cisco Press, ISBN 1-58720-083-X) Page 310.

QUESTION 387

What kind of message does a PING send out to test connectivity?

- A. ICMP echo request
- B. Information interrupt request
- C. Timestamp reply
- D. Source quench
- E. None of the above

Answer: A

Explanation:

The ping command sends an ICMP echo request packet to the stated destination address. The TCP/IP software at the destination then replies to the ping echo request packet with a similar packet, called the ICMP echo reply.

Reference: CCNA Self-Study CCNA ICND exam certification Guide (Cisco Press, ISBN 1-58720-083-X) Page 146

QUESTION 388

The relevant configuration files for the Certkiller 1 and Certkiller 2 routers are displayed below:

<pre>Certkiller 1# show running-config <some output text omitted> enable password cisco ! hostname Certkiller 1 username Certkiller 2 password cisco ! interface serial 0/0 ip address 10.0.8.1 255.255.248.0 encapsulation ppp ppp authentication chap</pre>	<pre>Certkiller 2# show running-config <some output text omitted> enable password cisco ! hostname Certkiller 2 username Certkiller 1 password cisco1 ! interface serial 0/0 ip address 10.0.15.2 255.255.248.0 encapsulation ppp ppp authentication chap</pre>
---	---

With due consideration to the command outputs, which of the following reasons would you attribute the connectivity problem between the two routers?

- A. The authentication needs to be changed to PAP for both routers.
- B. The serial IP addresses of routers are not on the same subnet.
- C. The username/password combination is incorrectly configured.
- D. The router names are incorrectly configured.

Answer: C

Explanation:

When configuring for CHAP authentication, you must enter the other router's user name and password. In this case on router Certkiller 2 has entered incorrect router Certkiller 1's password, which is "cisco1" (it must be "cisco"). As a result CHAP authentication will fail, therefore the connection establishment between the routers will be refused.

Reference:

CCNA Self-Study CCNA ICND

Exam Certification Guide

Chapter 9 page 315

ISBN: 1-58720-083-x

Incorrect Answers:

- A. Either PAP or CHAP can be used for these routers.
- B. Although this appears to be true at first glance, the subnet mask is 255.255.248.0, and the IP addresses on each side of the link are indeed on the same subnet.
- D. The hostnames are configured correctly, but the passwords do not match.

QUESTION 389

There is a connectivity problem between the serial 0/0 interface of router Certkiller 1 and the serial 0/0 interface of Certkiller 2. A leased line point to point circuit is installed between these two routers. The output from the "show interface serial 0/0" command is displayed below for each of these routers:

Certkiller 1:

```
Serial0/0 is up, line protocol is down
Hardware is HD64570
Internet address is 210.93.105.1/24
MTU 1500 bytes, BW 1544 Kbit, DLY 20000 usec,
reliability 255/255, txload 1/255, rxload 1/255
Encapsulation HDLC, loopback not set
Keepalive set (10 sec)
```

Certkiller 2:

```
Serial0/0 is up, line protocol is down
Hardware is HD64570
Internet address is 210.93.105.2/24
MTU 1500 bytes, BW 1544 Kbit, DLY 20000 usec,
reliability 255/255, txload 1/255, rxload 1/255
Encapsulation PPP, loopback not set
Keepalive set (10 sec)
```

From your observations of the above exhibit, what is the underlying cause of the problem?

- A. The loopback is not set.
- B. The serial cable is faulty.
- C. The subnet mask is not configured properly.

- D. The IP address is not configured properly.
- E. The Layer 2 frame types are not compatible.
- F. The keepalive setting is not configured properly.

Answer: E

Explanation:

If you see that the line is up but the protocol is down, as just above, you are experiencing a clocking (keepalive) or framing problem. Check the keepalives on both ends to make sure that they match, that the clock rate is set if needed, and that the encapsulation type is the same on both ends. This up/down status would be considered a Data Link Layer (Layer 2) problem. In this specific case, one end of the link is set to PPP encapsulation, and the other end is using HDLC, which is the Cisco proprietary method. Both sides of the connection must be using the same protocol.

QUESTION 390

The Certkiller network consists of the Holyoke and Chicopee locations as shown below:



Users on the Holyoke router cannot get access to the intranet server attached to interface E0 of the Chicopee router. After investigating you discover that the routing table of the Holyoke router shows that an entry for the Chicopee E0 network is missing.

Which of the command lines below will properly configure the Holyoke router to allow the users access to the intranet server's network?

- A. Holyoke(config)# ip host Chicopee 201.73.127.2
- B. Holyoke(config)# ip network 202.18.38.0
- C. Holyoke(config)# ip network 202.18.18.0 255.255.255.0
- D. Holyoke(config)# ip host Chicopee 201.73.127.0 255.255.255.0
- E. Holyoke(config)# ip route 202.18.18.0 255.255.255.0 201.73.127.2
- F. Holyoke(config)# ip route 201.73.127.0 255.255.255.0 202.18.18.0

Answer: E

Explanation:

We need to add a route for the 202.18.18.0/24 network. We can do this with the ip route command. The syntax is: ip route <network> <mask> <gateway>.

QUESTION 391

While logged into a router you manually shut down the serial 0 interface using the "shutdown" interface configuration command. You then issue the "show interface serial 0" command in exec mode. What could you expect the status of the serial 0 interface to be?

- A. Serial 0 is up, line protocol is up
- B. Serial 0 is up, line protocol is down
- C. Serial 0 is down, line protocol is down
- D. Serial 0 is down, line protocol is up
- E. Serial 0 is administratively down, line protocol is down
- F. Serial 0 is administratively down, line protocol is up

Answer: E

Explanation:

To bring down an interface for administrative reasons and, as a side effect, remove the connected router from the routing table, you can use the shutdown interface subcommand. To enable the interface back up, issue the "no shutdown" configuration command.

Incorrect Answers:

- A. This is the status of a fully operational interface.
- B, C. These are the results of line problems or configuration errors.
- D, F. These two interface conditions should never be seen.

QUESTION 392

While troubleshooting a network connectivity issue, you suspect that a router may be missing a route, or may be receiving bad routing information to a destination. What command should you issue to view the route that the router will use to reach a given destination?

- A. ping
- B. trace
- C. show ip route
- D. show interface
- E. show cdp neighbors

Answer: C

Explanation:

To view the IP routing table, issue the "show ip route" command. This can be used to verify a route to a destination.

QUESTION 393

You are the new system administrator at Certkiller .com and have just installed a brand new Cisco router to the Certkiller network. After configuring the router, you try to ping the directly connected serial port of the neighboring router, which was unsuccessful. You then entered the command, 'show running-config' and noticed the phrase 'shutdown' describing the serial interface. If you typed in the command 'show interface s0' what output would you see?

- A. Serial 0 is up, line protocol is down
- B. Serial 0 is down, line protocol is down
- C. Serial 0 is down, line protocol is up
- D. Serial 0 is administratively down, line protocol is down
- E. Serial 0 is administratively down, line protocol is up
- F. Serial 0 is administratively up, line protocol is down

Answer: D

Explanation:

If an interface is shutdown, it will show "administratively down and line protocol down"

QUESTION 394

Three routers are connected together via serial lines as shown below:



Certkiller 1 issues a ping to Certkiller 2, but the ethernet0 interface on router Certkiller C is down. Based on this information, which two of the answer choices below are correct? (Select two answer choices)

- A. Certkiller C will make use of ICMP to inform Certkiller 1, Certkiller A, and Certkiller B that Host 2 is unreachable.
- B. Certkiller C will send a Destination Unreachable message type.
- C. Certkiller C will make use of ICMP to inform Certkiller 1 that Certkiller 2 is unreachable.
- D. Certkiller C will use ICMP to inform Certkiller B that Certkiller 2 is unreachable.
- E. Certkiller C will issue a Router Selection message type.
- F. Certkiller C will issue a Source Quench message type.

Answer: B, C

Explanation

ICMP is an error-reporting protocol for IP. When datagram delivery error occur, ICMP reports these errors to the sender of the datagram.

When the e0 interface on Certkiller C goes down, Certkiller C uses ICMP to send a

message back to Certkiller 1 indicating that the datagram could not be delivered. ICMP does not correct the encountered network problem. Certkiller C will not notify the intermediary devices of the delivery failure. Therefore, Certkiller C will not send ICMP messages to Certkiller B. Datagrams contain only source and destination IP addresses, they do not contain information about all the intermediary devices. The reporting device (Certkiller C) has only the sender's IP address with which to communicate. Although Certkiller A and B are not notified directly, they might become aware of the down interface on Certkiller C. However, disseminating this information to neighbor routers is not the function of ICMP. ICMP reports on the status of the delivered packet to the sender, its function is not to propagate information about network changes.

QUESTION 395

Exhibit

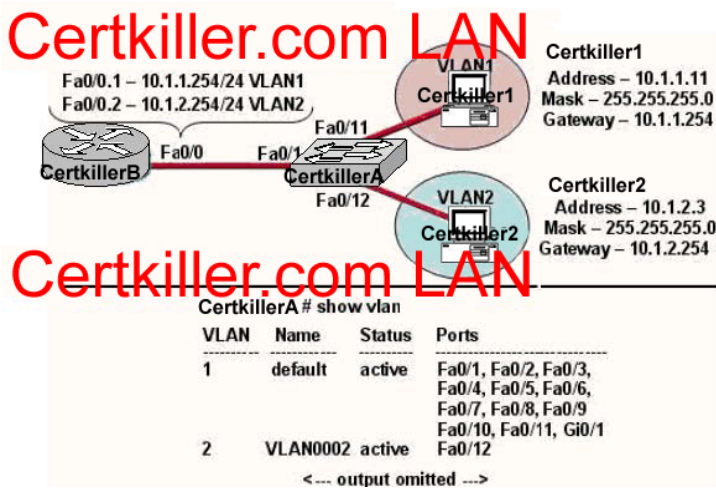

Study the exhibit: the topology and the partial switch command output. The internetwork shown in the exhibit is experiencing connectivity problems. Host Certkiller 1 is unable to ping Host Certkiller 2. What needs to be done to enable these hosts to ping each other?

- A. The gateway on Host Certkiller 1 needs to be changed.
- B. The IP address on Host Certkiller 2 needs to be reconfigured.
- C. VLAN2 must be named.
- D. The Fa0/1 interface on the Certkiller A switch must be configured as a trunk port.
- E. Switch port Fa0/1 must be moved to a different VLAN.

Answer: D

Explanation:

Interface FA0/1 should be in any case configured as a trunk port so that a router could switch packets between the VLANs. The IP addresses are ok.

QUESTION 396

Exhibit

Certkiller.com LAN

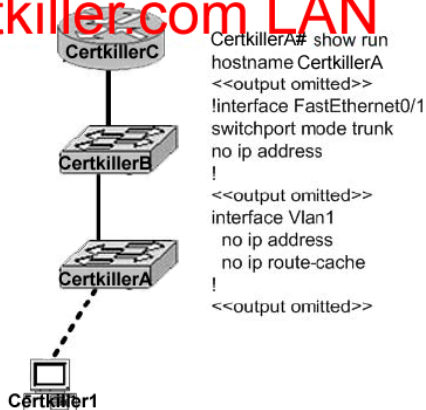

Study the exhibit. Host Certkiller 1 is consoled into Switch Certkiller

A. Telnet

connections and pings run from the command prompt on Switch Certkiller A fail.

Which of the following could cause this problem?

- A. Switch Certkiller A is not directly connected to router Certkiller C.
- B. Switch Certkiller A does not have a default gateway assigned.
- C. Switch Certkiller A does not have a CDP entry for Switch Certkiller B or Router Certkiller C.
- D. Switch Certkiller A does not have an IP address.
- E. Port 1 on Switch Certkiller A should be an access port rather than a trunk port.

Answer: B, D

For ping and Telnet the switch should be configured with the IP address and the default gateway. IP is used for administrative purposes.

QUESTION 397

Which IOS user EXEC command will allow a network technician to determine which router in the path to an unreachable network host should be examined more closely for the cause of the network failure?

- A. Certkiller B> telnet
- B. Certkiller B > ping
- C. Certkiller B > trace
- D. Certkiller B > show ip route
- E. Certkiller B > show interface
- F. Certkiller B > show cdp neighbors

Answer: C

This can perform the trace command. It sends the ping packets to each of the routers on the way to the receiver. The router which doesn't respond will be a potential failure place in this consecution.

QUESTION 398

Exhibit

Capability Codes: R - Router, T - Trans Bridge, B - Source Route Bridge
 S - Switch, H - Host, I - IGMP, r - Repeater

Device ID	Local Interface	Remote Interface	Capability	Platform	Port ID
Certkiller1	Ser 0/1	160	R	2621	Ser 0/1

Certkiller2#

What is the meaning of the output of the show cdp neighbors command in the exhibit?

- A. The Certkiller 2 router has a route to the Certkiller 1 router using the Serial 0/1 interface. The route can be directly connected or remote.
- B. The Certkiller 1 switch directly connects to the Certkiller 2 router using the Serial 0/1 interface on both Cisco devices.
- C. The Certkiller 2 device is a Cisco router, and it connects using the Serial 0/1 interface to the Certkiller 1 Cisco router's Serial 0/1 interface.
- D. The Certkiller 2 device is a non-Cisco device that connects to a Cisco router using the Serial 0/1 interface on both devices.

Answer: C

QUESTION 399

Exhibit

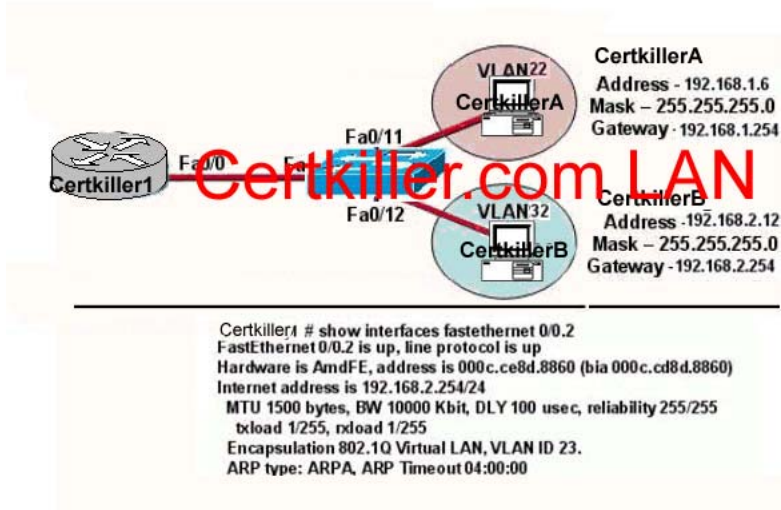

Host Certkiller B in the diagram is experiencing connectivity problems. Testing reveals that it cannot ping the default gateway.

Based on the information shown in the exhibit, what is the problem?

- A. The IP address of Certkiller B is on a different subnet than the default gateway.
- B. The Fa0/1 interface on the switch is administratively shutdown.
- C. The switch is connected to the wrong interface on the Certkiller 1 router.
- D. The FastEthernet interface on the Certkiller router is not configured for trunking.
- E. The Fastethernet 0/0.2 interface on the Certkiller 1 router is configured for the wrong VLAN.
- F. The FastEthernet interface of the Certkiller 1 router is configured with the wrong Ethernet encapsulation.

Answer: E

QUESTION 400

On your newly installed router, you apply the access list illustrated below to interface Ethernet 0 on a Cisco router. The interface is connected to the 192.168.1.8/29 LAN.

```
access-list 123 deny tcp 192.168.166.18 0.0.0.7 eq 20 any
```

```
access-list 123 deny tcp 192.168.166.18 0.0.0.7 eq 21 any
```

How will the above access lists affect traffic?

- A. All traffic will be allowed to exit E0 except FTP traffic.
- B. FTP traffic from 192.168.166.19 to any host will be denied.
- C. FTP traffic from 192.168.166.22 to any host will be denied.
- D. All traffic exiting E0 will be denied.
- E. All FTP traffic to network 192.168.166.18/29 from any host will be denied.

Answer: D

Explanation:

By default every access list contains an implicit deny statement at the end. Because of this, only an access list that contains at least one permit statement will be useful. In this example there is no permit statement, so it will deny all traffic exiting E0 Interface.

Incorrect Answers:

- A. It will deny everything, including FTP and telnet traffic.
- B, C, E. It will deny all traffic in addition to the condition mentioned in these answers, because there is no permit statement at the end.